

RICOH

Priport

JP5000

OPERATING INSTRUCTIONS

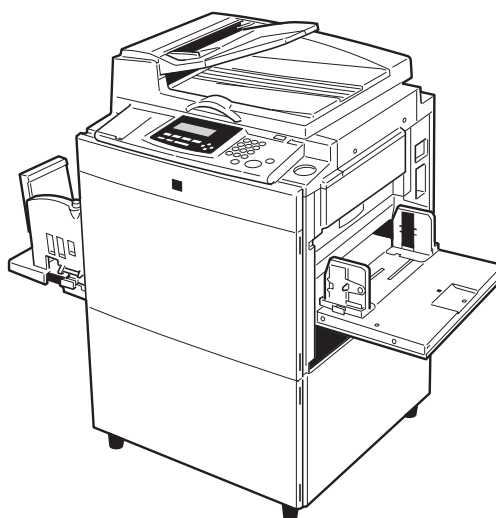

TPEH162N

Read this manual carefully before you use this product and keep it handy for future reference.

For safety, please follow the instructions in this manual.



RICOH COMPANY, LTD.

15-5, 1 chome, Minami-Aoyama, Minato-ku, Tokyo
Telephone: Tokyo 3479-3111

Overseas Affiliates

U.S.A.

RICOH CORPORATION
5 Dedrick Place West Caldwell, New
Jersey 07006
Phone: +1-973-882-2000

The Netherlands

RICOH EUROPE B.V.
Groenelaan 3, 1186 AA, Amstelveen
Phone: +31-(0)20-5474111

United Kingdom

RICOH UK LTD.
Ricoh House, 1 Plane Tree Cres-
cent, Feltham, Middlesex, TW13
7HG
Phone: +44-(0)181-261-4000

Germany

RICOH DEUTSCHLAND GmbH
Mergenthaler Allee 38-40, 65760
Eschborn
Phone: +49-(0)6196-9060

France

RICOH FRANCE S.A.
383, Avenue du Général de Gaulle-
BP 307-92143 Clamart Cedex
Phone: +33-(0)1-40-94-38-38

Spain

RICOH ESPAÑA S.A.
Av.Litoral Mar, 12-14, 08005 Barcelo-
na
Phone: +34-(0)3-295-7600

Italy

RICOH ITALIA SpA
Viale Della Metallurgia 12, Zona
Basson 37139 Verona
Phone: +39-(0)45-8181500

Hong Kong

RICOH HONG KONG LTD.
23/F., China Overseas Building, 139,
Hennessy Road, Wan Chai, Hong
Kong
Phone: +852-2862-2888

Singapore

RICOH ASIA PACIFIC PTE.LTD.
260 Orchard Road, #15-01/02 The
Heeren, Singapore 238855
Phone: +65-830-5888

Introduction

This manual contains detailed instructions on the operation and maintenance of this machine. To get maximum versatility from this machine all operators should carefully read and follow the instructions in this manual. Please keep this manual in a handy place near the machine.

Please read the Safety Information before using this machine. It contains important information related to USER SAFETY and PREVENTING EQUIPMENT PROBLEMS.

Power Source:

220 – 240 V, 50/60 Hz, 1.5 A or more

Please be sure to connect the power cord to a power source as above. For details about power source, see ⇒ P.194 *"Power connection"*.



Notes:

Some illustrations might be slightly different from your machine.

Certain options might not be available in some countries. For details, please contact your local dealer.



Two kinds of size notation are employed in this manual. With this machine refer to the Metric version.

For good copy quality, Ricoh recommends that you use genuine Ricoh master and ink.

Ricoh shall not be responsible for any damage or expense that might result from the use of parts other than genuine Ricoh parts in your Ricoh office product.

In accordance with ISO Standard 7001, this machine uses the following symbols for the main switch:

I means **POWER ON.**

O means **POWER OFF.**

Safety Information

When using your machine, the following safety precautions should always be followed.

Safety During Operation

In this manual, the following important symbols are used:

 **WARNING:**
Ignoring this warning could cause serious injury or even death.

 **CAUTION:**
Ignoring this caution could cause injury or damage to property.

Examples Of Indications



Symbols  mean a situation that requires you take care.



Do NOT carry out the operation represented by this symbol .
This example means “Do not take apart”.



Symbols  mean you MUST perform this operation.
This example means “You must remove the wall plug”.

Warning:



- **Only connect the machine to the power source described on the inside front cover of this manual.**
- **Avoid multi-wiring.**
- **Do not damage, break or make any modifications to the power cord. Do not place heavy objects on it, pull it hard or bend it more than necessary. These actions could cause an electric shock or fire.**
- **Do not plug or unplug the power cord with your hands wet. Otherwise, an electric shock might occur.**



- **Make sure the wall outlet is near the machine and freely accessible so that in event of an emergency it can be unplugged easily.**



- **Do not remove any covers or screws other than those specified in this manual. Some parts of the machine are at a high voltage and could give you an electric shock. When the machine needs to be checked, adjusted, or repaired, contact your service representative.**
- **Do not take apart or attempt any modifications to this machine. There is a risk of fire, electric shock, explosion or loss of sight.**



- **If the machine looks damaged or breaks down, smoke is coming out, there is a strange smell or anything looks unusual, immediately turn off the main switch then unplug the power cord from the wall. Do not continue using the machine in this condition. Contact your service representative.**
- **If metal, liquid or foreign matter falls into the machine, turn off the main switch and unplug the main power cord. Contact your service representative. Do not keep using the machine with a fault or defect.**



- **Do not put any metal objects or containers holding water (e.g. vases, flowerpots, glasses) on the machine. If the contents fall inside the machine, a fire or electric shock could occur.**

Caution:



- *Keep the machine away from humidity and dust. A fire or an electric shock might occur.*
- *Do not place the machine on an unstable or tilted surface. If it topples over, it could cause injury.*



- *After you move the machine, fix it with the caster fixture. Otherwise, the machine might move or come down to cause a personal injury.*



- *When you move the machine, unplug the power cord from the wall outlet to avoid fire or electric shock.*
- *When the machine will not be used for a long time, unplug the power cord.*

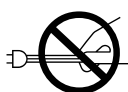

- *When you pull out the plug from the socket, grip the plug to avoid damaging the cord and causing fire or electric shock.*



- *If you use the machine in a confined space, make sure there is a continuous air turnover.*



- *Do not reuse stapled paper. Do not use aluminum foil, carbon-containing paper or other conductive paper. Otherwise, a fire might occur.*



- *This machine has been tested for safety using this supplier's parts and consumables. We recommend you only use these specified supplies.*



- *This equipment is only to be installed by a qualified service personnel.*



- *Deliver to collection point for waste products. Do not be disposed of via domestic refuse collection.*



- *If ink comes into contact with your eyes, rinse immediately in running water. In the case of any abnormal symptoms, consult a doctor.*



- *Keep the ink or ink container out of reach of children.*



- *If ink is ingested, force vomiting by drinking a strong saline solution and consult a doctor immediately.*



- *Be careful not to cut yourself on any sharp edges when you reach inside the machine to remove misfed sheets of paper or masters.*



- *While printing, do not touch the belt at the end of the paper delivery tray or the job separator. You might be injured.*



- *When your machine is equipped with the PC controller option:*
 - *Do not place this equipment on an unstable or tilted surface. If you do, it could fall.*
 - *Do not place heavy objects on top of this equipment. They might cause the equipment to become unstable and topple over.*



- *When your machine is equipped with the PC controller option:*
 - *If by any chance this equipment falls over or a breakage occurs (e.g., the cover), turn off the main switch of this equipment, unplug the power cable and contact your service representative. If you continue to use the equipment in this state it could result in fire or electric shock.*

How To Read This Manual

Symbols

In this manual, the following symbols are used:

 **WARNING:**

This symbol indicates a potentially hazardous situation that might result in death or serious injury when you misuse the machine without following the instructions under this symbol. Be sure to read the instructions, all of which are described in the Safety Information section.

 **CAUTION:**

This symbol indicates a potentially hazardous situation that might result in minor or moderate injury or property damage that does not involve personal injury when you misuse the machine without following the instructions under this symbol. Be sure to read the instructions, all of which are described in the Safety Information section.

* The statements above are notes for your safety.

 **Important**

If this instruction is not followed, paper might be misfed, originals might be damaged, or data might be lost. Be sure to read this.

 **Preparation**

This symbol indicates the prior knowledge or preparations required before operating.

 **Note**

This symbol indicates precautions for operation, or actions to take after misoperation.

 **Limitation**

This symbol indicates numerical limits, functions that cannot be used together, or conditions in which a particular function cannot be used.

 **Reference**

This symbol indicates a reference.

[]

Keys that appear on the machine's panel display.

[]

Keys built into the machine's operation panel.

Making Prints

Before making prints using this machine, you have to make a master by pressing the **[Start]** key. When you press the **[Start]** key, the machine scans the original image and makes a master. This procedure describes how to make basic prints.

1 Set your originals.

When you set original on the exposure glass (contact glass)

1 Set one original face down.

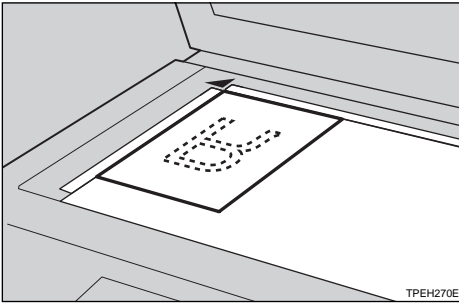

When you set originals in the optional document feeder

1 Set the originals face up.

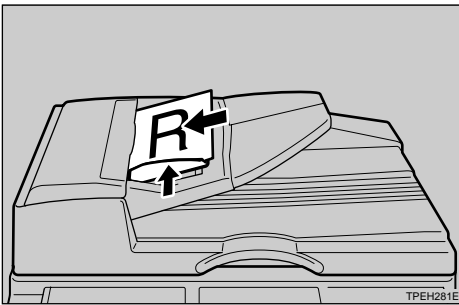

2 Press the **[Start]** key.

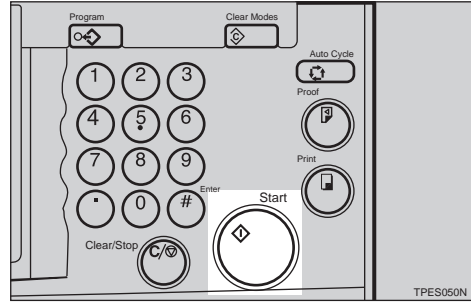

3 Press the **[Proof]** key.

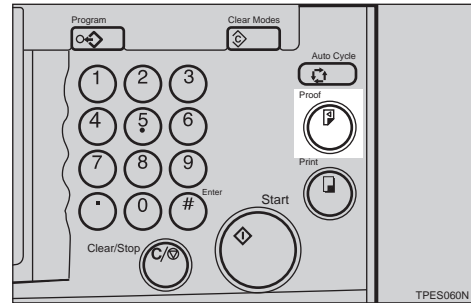

Check the print image.

🔍 Reference

When you want to change the image position, see ⇒ P.25 “Adjusting Print Image Position”.

Ready for Master Making/ Printing			
	A4		0.0mm
Letter	100%	Std.	0.0mm
Original	Ratio	Ppr.Type	Image



When you want to increase the image density, press the **[◀]** key. See ⇒ P.26 “Adjusting Print Image Density”.

When you want to decrease the image density, press the **[▶]** key.

key. See ⇒ P.26 “Adjusting Print Image Density”.

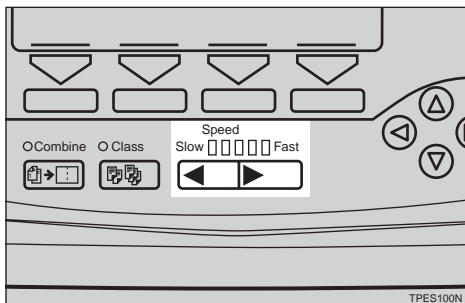

- 4 Enter the desired number of prints with the Number keys.

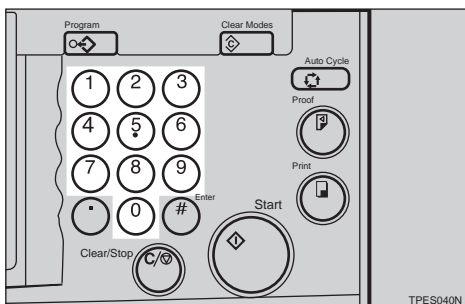

- 5 Press the [Print] key.

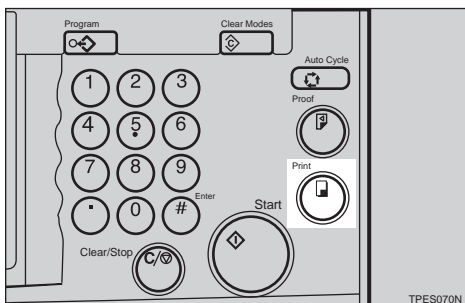

When the print job has finished, press the **[Clear Modes]** key. Previously entered job settings will be cleared.

❖ **Stretching And Squeezing The Image In 1 % Steps**

See ⇒ P.37 *“Directional Magnification—Stretching And Squeezing The Image In 1 % Steps”*.

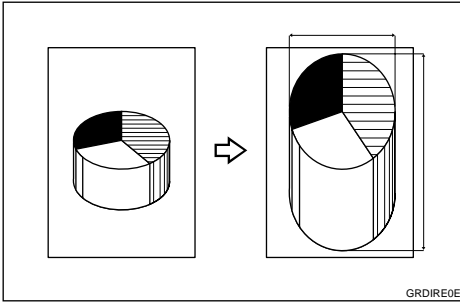

❖ **Erasing Edge Margins**

See ⇒ P.40 *“Edge Erase—Erasing Edge Margins”*.

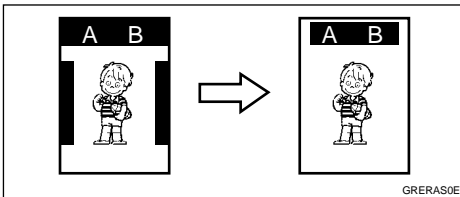

❖ **Printing On Various Kinds Of Paper**

See ⇒ P.42 *“Printing On Various Kinds Of Paper”*.

❖ **Selecting A Mode To Match Your Original**

See ⇒ P.45 *“Selecting A Mode To Match Your Original”*.

❖ **Saving Ink**

See ⇒ P.48 *“Economy Mode—Saving Ink”*.

❖ **Making Master And Prints At One Stroke**

See ⇒ P.49 *“Auto Cycle—Making Master And Prints At One Stroke”*.

❖ **Making Variable Numbers Of Prints From The Same Original Using All Stored Data**

See ⇒ P.51 *“All Class Mode—Making Variable Numbers Of Prints From*

The Same Original Using All Stored Data”.

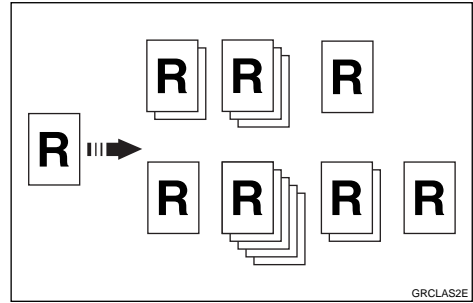

❖ **Making Variable Numbers Of Prints From The Same Original Using Stored Data**

See ⇒ P.53 *“Auto Class Mode—Making Variable Numbers Of Prints From The Same Original Using Stored Data”*.

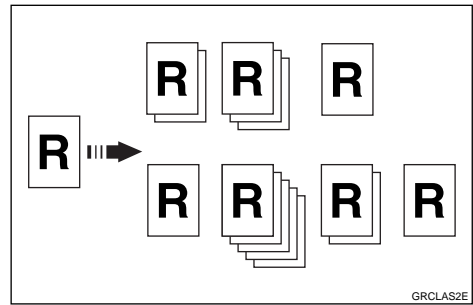

❖ **Making Variable Numbers Of Prints From The Same Original**

See ⇒ P.56 *“Manual Class Mode With One Original—Making Variable Numbers Of Prints From The Same Original”*.

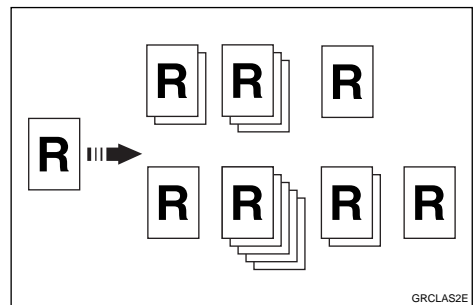

❖ **Making Variable Numbers Of Prints From Different Originals**

See ⇒ P.58 *“Manual Class Mode With 2 Or More Originals—Making Variable Numbers Of Prints From Different Originals”*.

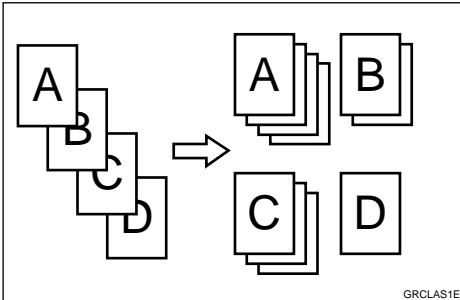

❖ **Making Fixed Numbers Of Prints From The Same Original**

See ⇒ P.61 *“Class Mode—Making Fixed Numbers Of Prints From The same Original”*.

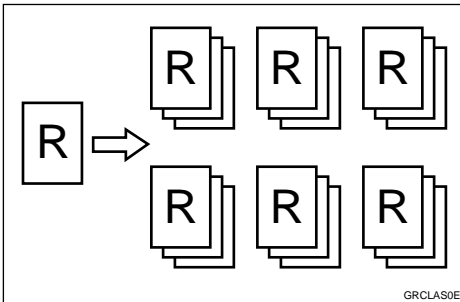

❖ **Combining Originals Into One Print**

See ⇒ P.63 *“Combine Originals—Combining Originals Into One Print”*.

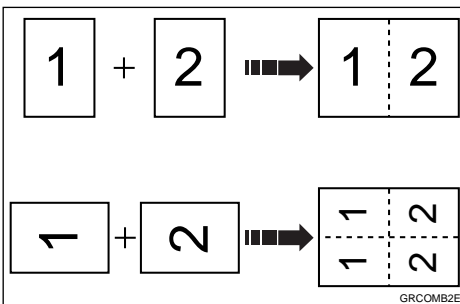

❖ **Having Images Repeated On One Print**

See ⇒ P.68 *“Auto Combine Mode—Having Images Repeated On One Print”*.

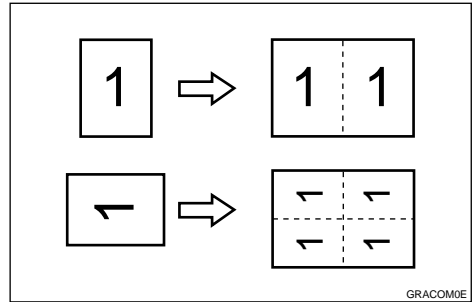

❖ **Skip Feed Printing**

See ⇒ P.70 *“Skip Feed Printing”*.

❖ **Storing Your Print Settings In Memory**

See ⇒ P.72 *“Program—Storing Your Print Settings In Memory”*.

❖ **Printing Secret Documents**

See ⇒ P.75 *“Security Mode—Printing Secret Documents”*.

❖ **Regaining The Image Density When The Ink On The Drum Dries**

See ⇒ P.76 *“Quality Start Mode—Regaining The Image Density When The Ink On The Drum Dries”*.

❖ **Separating Printing Sets On The Paper Delivery Tray**

See ⇒ P.77 *“Job Separation—Separating Printing Sets On The Paper Delivery Tray”*.

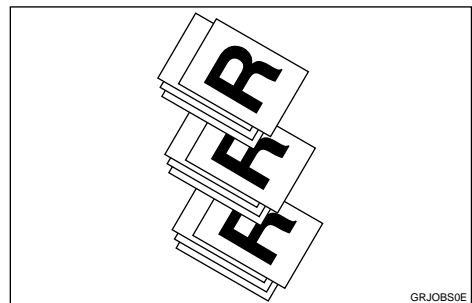

❖ **Saving Master**

See ⇒ P.79 *“Saving Master”*.

- ❖ **On Line Printing**
See ⇒ P.80 *“On Line Printing”*.
- ❖ **Making Color Prints**
See ⇒ P.87 *“Making Color Prints”*.
- ❖ **Printing In Two Colors**
See ⇒ P.88 *“Printing In Two Colors”*.

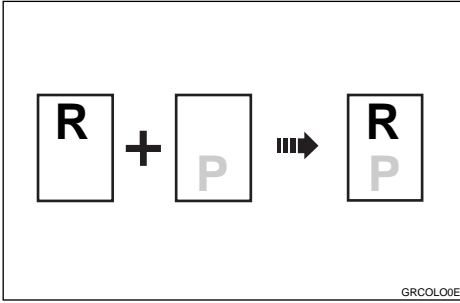

- ❖ **Rotating The Original Images**
See ⇒ P.91 *“Image Rotation—Rotating Original Images”*.
- ❖ **Make-up Printing**
See ⇒ P.105 *“Make-up Printing”*.
- ❖ **Merging Images**
See ⇒ P.113 *“Image Overlay—Merging Images”*.

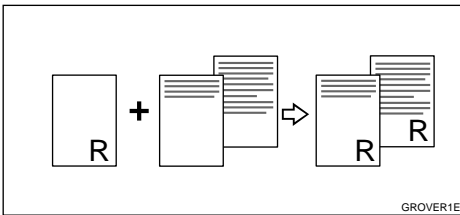
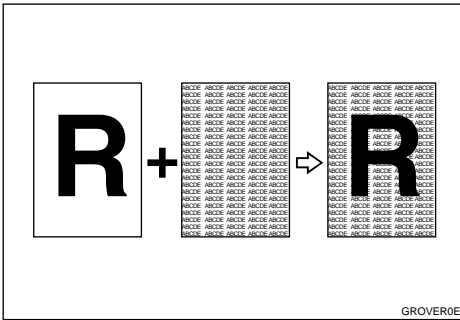

- ❖ **Having The Date Stamped On Your Prints**
See ⇒ P.115 *“Stamping Date—Having The Date Stamped On Your Prints”*.

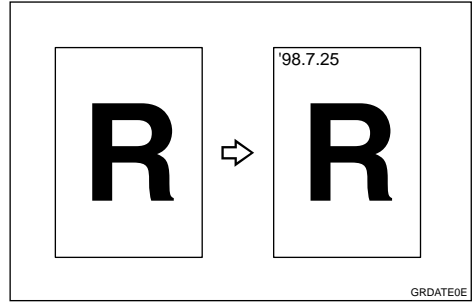

- ❖ **Having Page Numbers Stamped On Your Prints**
See ⇒ P.117 *“Page Stamping—Having Page Numbers Stamped On Your Prints”*.

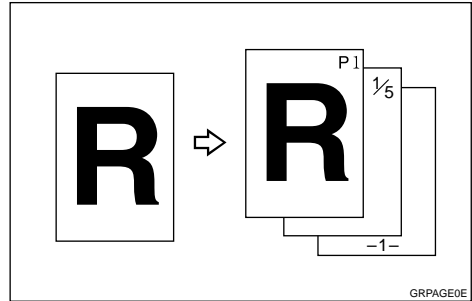

- ❖ **Printing Preset Messages On Your Prints**
See ⇒ P.120 *“Stamping Function—Printing Preset Messages On Your Prints”*.

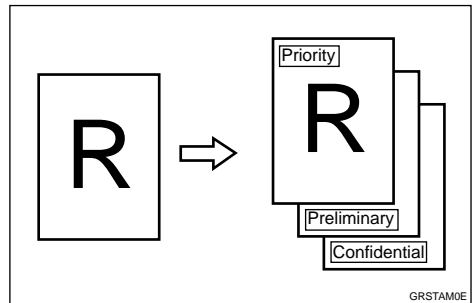

❖ **Printing Your Own Messages On Your Prints**

See ⇒ P.122 *“User Stamping—Printing Your Own Messages On Your Prints”*.

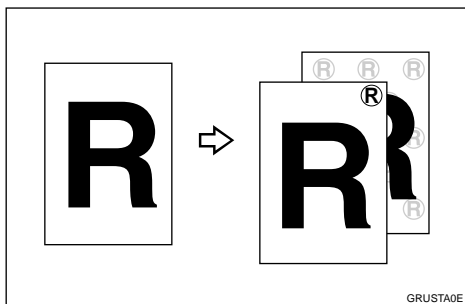

❖ **Combining Originals Into One Print With The Memory Board**

See ⇒ P.124 *“Memory Combine—Combining Originals Into One Print With The Memory Board”*.

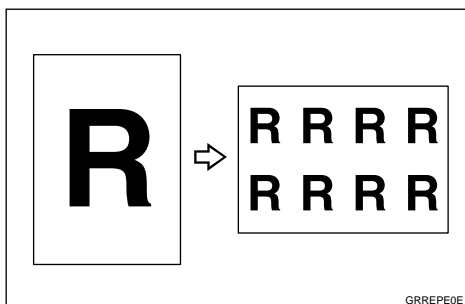
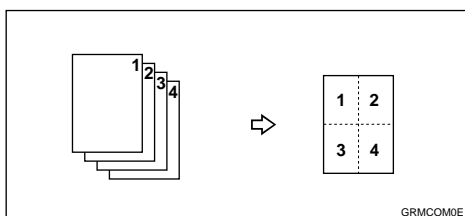

TABLE OF CONTENTS

Machine Exterior	1
Machine Interior	2
Options	4
Operation Panel	6
Keys.....	6
Indicators.....	8
Panel Display	9
Display Panel Layout.....	10

1. OPERATION

Printing Paper	11
Originals	13
Preparation For Printing	15
Loading Paper.....	15
Setting Up The Paper Delivery Tray.....	16
User Codes	19
Standard Printing	20
Loading Paper On The Paper Feed Tray	22
Replenishing Paper.....	22
Changing The Paper Size.....	23
Closing The Paper Feed And Paper Delivery Trays	24
Adjusting Print Image Position	25
Adjusting Print Image Density	26
Before Making A Master.....	26
After Making A Master.....	26
Tint Mode—Halftone Printing	27
Changing The Printing Speed	28
Stopping The Machine During A Multi-print Run	29
When You Want To Stop The Machine During A Multi-print Run And Print A Different Original.....	29
When You Want To Change The Number Of Prints Entered Or Check The Completed Prints.....	29
Preset Reduce/Enlarge—Reducing And Enlarging Using Preset Ratios ...	30
Auto Magnification Selection—Having The Machine Choose The Reproduction Ratios	32
Zoom—Reducing And Enlarging In 1 % Steps	35
Directional Magnification—Stretching And Squeezing The Image In 1 % Steps ...	37
Entering The Reproduction Ratios.....	37

Entering The Dimensions Of The Original And Print Paper	38
Edge Erase—Erasing Edge Margins.....	40
Printing On Various Kinds Of Paper.....	42
Printing On Thick Paper	42
Printing On Thin Paper.....	42
Printing On Envelopes	43
Printing On Special Kinds Of Paper	43
Selecting A Mode To Match Your Original.....	45
Photo Mode Printing.....	45
Letter/Photo Mode Printing	46
Pencil Mode Printing	47
Economy Mode—Saving Ink	48
Auto Cycle—Making Master And Prints At One Stroke.....	49
All Class Mode—Making Variable Numbers Of Prints From The Same Original Using All Stored Data.....	51
Auto Class Mode— Making Variable Numbers Of Prints From The Same Original Using Stored Data	53
Manual Class Mode With One Original—Making Variable Numbers Of Prints From The Same Original.....	56
Manual Class Mode With 2 Or More Originals—Making Variable Numbers Of Prints From Different Originals	58
Class Mode—Making Fixed Numbers Of Prints From The same Original	61
Combine Originals—Combining Originals Into One Print.....	63
Auto Combine Mode—Having Images Repeated On One Print	68
Skip Feed Printing.....	70
Program—Storing Your Print Settings In Memory	72
Storing Your Settings	72
Recalling A Program	73
Protecting A Program.....	73
Removing Program Protection	74
Security Mode—Printing Secret Documents	75
Quality Start Mode— Regaining The Image Density When The Ink On The Drum Dries.....	76
Using Quality Start Manually	76
Job Separation—Separating Printing Sets On The Paper Delivery Tray.....	77
Saving Master	79
On Line Printing.....	80

2. OPTIONAL FUNCTIONS

Printing Using The Optional Document Feeder.....	81
Originals	81
Setting Originals In The Document Feeder.....	82
Combine Originals Printing With The Document Feeder	83
Manual Class Mode With 2 Or More Originals Using The Document Feeder...	84
Color Printing Using The Optional Color Drum.....	87
Making Color Prints.....	87
Changing The Color Drum Unit.....	87
Printing In Two Colors.....	88
Changing The Drum Size.....	90
Printing Area (at 23°C/73°F, 65 % RH).....	90
Master Cut Length.....	90
Image Rotation—Rotating Original Images	91
Make-up Printing Features	93
Main Features	93
Make-up Modes For Designated Areas	93
Make-up Modes For Outside Designated Areas	94
Background Patterns.....	96
Making A Command Sheet For Make-Up Printing.....	98
Command sheet.....	98
How To Make A Command Sheet.....	99
Command Sheets And Finished Prints	104
Make-up Printing	105
Make-up Printing With The Optional Document Feeder	107
Make-up Samples	110
Image Overlay—Merging Images.....	113
Stamping Date—Having The Date Stamped On Your Prints.....	115
Page Stamping—Having Page Numbers Stamped On Your Prints ..	117
Stamping Function—Printing Preset Messages On Your Prints	120
User Stamping—Printing Your Own Messages On Your Prints	122
Memory Combine—Combining Originals Into One Print With The Memory Board	124
Combine 4, 8, or 16 Originals – 4, 8, or 16 One-sided Originals → 1 One-sided Print Of 4, 8, or 16 Images	125
Repeat—Repeating An Image Over The Entire Print	129

3. USER TOOLS

Accessing The User Tools.....	133
User Tools Menu.....	135
1. System	135

2. Set Operation Modes	136
3. Initial Setting.....	137
4. Mode Setting	139
5. Stamp	144
6. Set User Code (s)	146
User Tool Menus In Detail.....	148
1-8 Time Setting.....	148
3-4 Reproduction Ratio	148
3-5 Class Enter No.....	149
3-9 Margin Erase Area	150
4-11 No. of Skip Feed	151
4-14 No. of Q.start.....	152
4-19 Type of Paper	154
5-4 Stamp Position	154
5-7 Position (User)	156
5-8 Regist. (User).....	158
5-11 Position (Date)	158
5-14 Position (Page)	160
5-15 Make/Chg. Pattern	161
6-1 Check Counter	162
6-2 Reset Counters	163
6-4 Chg. User Code	163
6-5 Del. User Code	164

4. What To Do If Something Goes Wrong

If Your Machine Does Not Operate As You Want	165
If You Cannot Make Prints As You Want.....	167
Combine Originals Mode.....	167
☞ Clearing Misfeeds.....	168
"☞ + A" Paper Misfeed In The Paper Feed Section	168
"☞ + A + B" Paper Misfeed In The Paper Feed Section.....	169
"☞ + B" Paper Or Master Wrapped Around The Drum.....	170
"☞ + C" Paper Misfeed In The Paper Exit Section	172
"☞ + D" Master Misfeed In The Master Feed Section	173
"☞ + D + B" Master Misfeed In The Master Feed Section.....	173
"☞ + B + E" Master Misfeed in The Master Eject Section	174
"☞ + E" Master Misfeed In The Master Eject Section.....	175
"☞ + P" Original Misfeed Occurs When Using The Optional Document Feeder....	175
When The Open Cover/Unit Indicator (☞) Lights.....	177
When The Add Ink Indicator (☞) Lights	178
When The Master End Indicator (☞) Lights.....	180
When The Master Eject Indicator (☞) Lights.....	182
When Other Indicators Are Lit.....	183
When The Prints Are Not Delivered In A Neat Stack.....	184

Poor Printing	185
Dirty Background.....	185
Black Line/Stain	188
Skipped Prints	188

5. REMARKS

Operation Notes	189
General Cautions	189
Print Paper	191
Originals	191
Misfed Paper	191
PC Controller.....	192
Where To Put Your Machine	193
Environmental Conditions	193
Power connection.....	194
Access to machine	194
Maintaining Your Machine	196
Main Frame	196
Optional Document Feeder	197
Combination Chart	198

6. SPECIFICATIONS

Main Frame	201
Document Feeder	205
Consumables	206
INDEX	207

This page is intentionally blank.

Machine Exterior

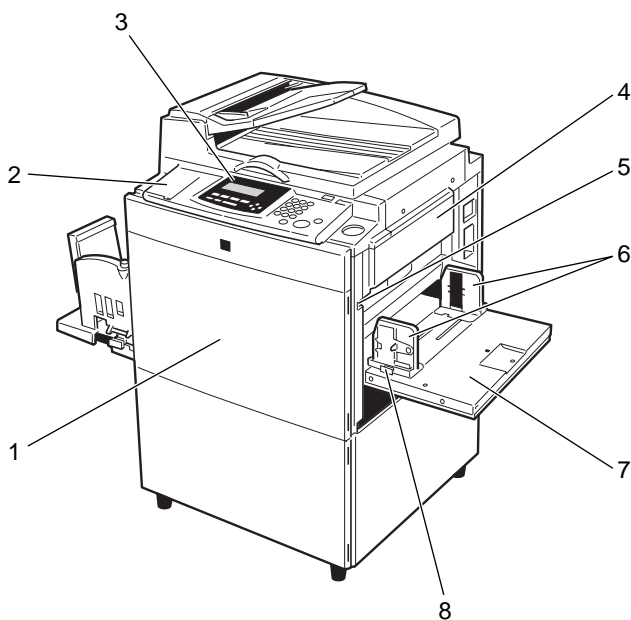

TPEH162E

1. Front Door

Open for access to the inside of the machine.

2. Flip-up Cover

Open to access the **[Image Density]** key and so on. See ⇒ P.6 "Operation Panel".

3. Operation Panel

Operator controls and indicators are located here. See ⇒ P.6 "Operation Panel".

4. Master Feed Unit

Open the master feed unit when installing the master.

5. Paper Feed Tray Down key

Press to lower the paper feed tray.

6. Paper Feed Side/End Plates

Use to prevent paper skew.

7. Paper Feed Tray

Set paper on this tray for printing.

8. Paper Feed Side/End Plate Knob

Use to move the side/end plates.

Machine Interior

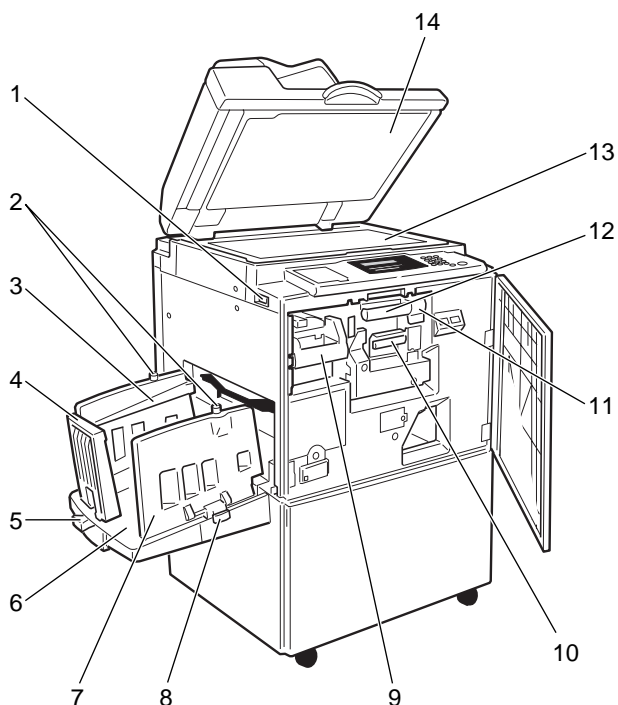

TPEH260E

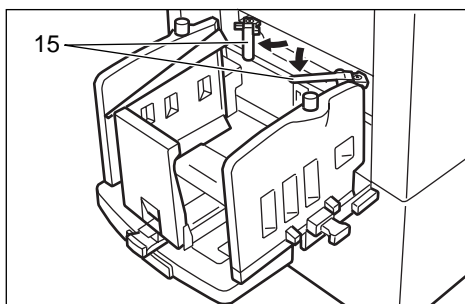

1. Main Switch

Use to turn the power on or off.

2. Paper Alignment Wing Knobs

Use to lift or lower the paper alignment wings.

3. Paper Alignment Wings

Lift or lower the wings depending on the paper type you use.

4. Paper Delivery End Plate

This plate aligns the leading edge of prints.

5. Paper Delivery End Plate Knob

Use to move the end plate.

6. Paper Delivery Tray

Completed prints are delivered here.

7. Paper Delivery Side Plates

These plates align the prints on the paper delivery tray.

8. Paper Delivery Side Plate Knobs

Use to move the side plates.

9. Master Eject Unit Front Handle E1

Use to pull out the master eject unit.

10. Ink Holder

Set the ink cartridge in this holder.

11. Drum Unit Lock Lever B1

Lower to unlock and pull out the drum unit.

12. Drum Unit

The master is wrapped around this unit.



13. Exposure Glass (Contact Glass)

Position originals here face down for printing.

14. Platen Cover

Lower this cover over an original before printing.

15. Trailing Edge Guides

Swing out these guides when you use A4, 8¹/₂" × 11"  or B5  paper.

Options

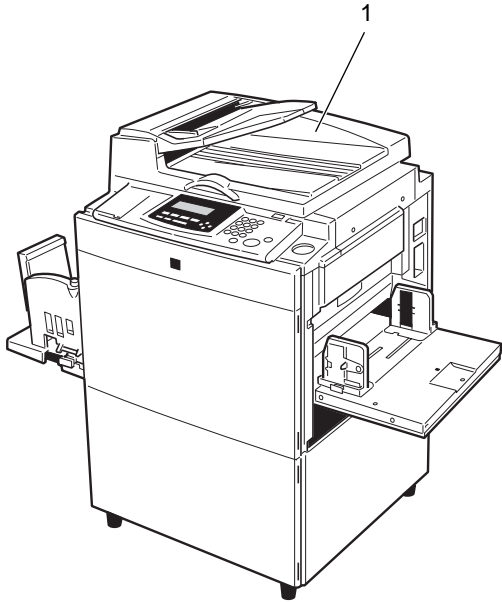

TPEH163E

1. Document Feeder

Note

Other options:

- Color Drums: A3, 11" × 17" drum (red, blue, green, and brown)
- Color Drums: A4, 8¹/₂" × 11" drum (black, red, blue, green, and brown)
- Key Counter
- Cabinet
- Memory Board
- PC Controller

This page is intentionally blank.

Operation Panel

Keys

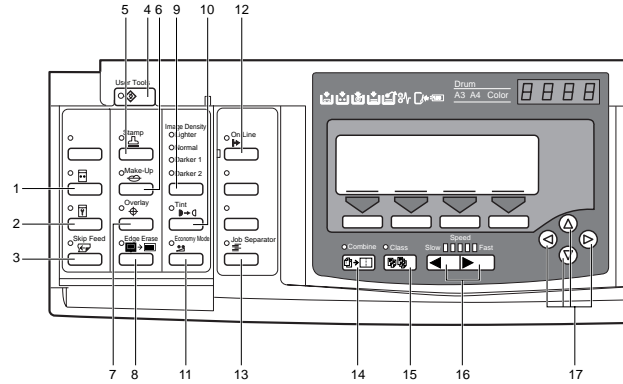

1. **【Quality Start】** key

See ⇒ P.76 “Quality Start Mode—Regaining The Image Density When The Ink On The Drum Dries”.

2. **【Security】** key

See ⇒ P.75 “Security Mode—Printing Secret Documents”.

3. **【Skip Feed】** key

Press to select skip feed printing. See ⇒ P.70 “Skip Feed Printing”.

4. **【User Tools】** key

Press to change the default settings and conditions to meet your requirements.

5. **【Stamp】** key

Press to select the optional Stamp function. See ⇒ P.115 “Stamping Date—Having The Date Stamped On Your Prints”, ⇒ P.117 “Page Stamping—Having Page Numbers Stamped On Your Prints”, ⇒ P.120 “Stamping Function—Printing Preset Messages On Your Prints”, ⇒ P.122 “User Stamping—Printing Your Own Messages On Your Prints”.

6. **【Make-Up】** key

Press to use the optional Make-up function. See ⇒ P.105 “Make-up Printing”.

7. **【Overlay】** key

Press to select optional Image Overlay mode. See ⇒ P.113 “Image Overlay—Merging Images”.

8. **【Edge Erase】** key

Press to print originals that have an unnecessary image on the edges. See ⇒ P.40 “Edge Erase—Erasing Edge Margins”.

9. **【Image Density】** key

Press to make prints darker or lighter. See ⇒ P.26 “Adjusting Print Image Density”.

10. **【Tint】** key

Press to reproduce tinted images. See ⇒ P.27 “Tint Mode—Halftone Printing”.

11. **【Economy Mode】** key

Press to save ink. See ⇒ P.48 “Economy Mode—Saving Ink”.

12. **【On Line】**key

See ⇒ P.80 “On Line Printing”.

13. **【Job Separator】** key

See ⇒ P.77 “Job Separation—Separating Printing Sets On The Paper Delivery Tray”.

14. **【Combine】** key

Press to combine originals onto 1 print. See ⇒ P.63 “Combine Originals—Combining Originals Into One Print”, ⇒ P.124 “Memory Combine—Combining Originals Into One Print With The Memory Board”, ⇒ P.68 “Auto Combine Mode—Having Images Repeated On One Print”.

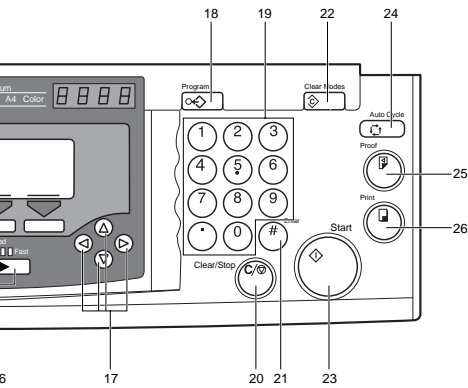

TPES011A

15. **[Class]** key

Press to select All Class, Auto Class, Manual Class, or Class mode. See ⇒ P.51 “All Class Mode—Making Variable Numbers Of Prints From The Same Original Using All Stored Data”, ⇒ P.53 “Auto Class Mode— Making Variable Numbers Of Prints From The Same Original Using Stored Data”, ⇒ P.56 “Manual Class Mode With One Original—Making Variable Numbers Of Prints From The Same Original”, ⇒ P.58 “Manual Class Mode With 2 Or More Originals—Making Variable Numbers Of Prints From Different Originals”, ⇒ P.61 “Class Mode—Making Fixed Numbers Of Prints From The same Original”.

16. **[Speed]** keys

Press to adjust the printing speed. See ⇒ P.26 “Adjusting Print Image Density”, ⇒ P.28 “Changing The Printing Speed”.

17. **[◀][▶][▲][▼]** keys

Press to shift the image forward, backward, right, or left. See ⇒ P.25 “Adjusting Print Image Position”.

They are also used to highlight the section you wish to select.

18. **[Program]** key

Press to input or recall user programs. See ⇒ P.72 “Program—Storing Your Print Settings In Memory”.

19. **Number** keys

Press to enter the desired number of prints and data for selected modes.

20. **[Clear/Stop]** key

While printing, press to stop the machine operation.

21. **[Enter]** key

Use to enter data in selected modes.

22. **[Clear Modes]** key

Press to clear the previously entered job settings.

23. **[Start]** key

Press to make a master.

24. **[Auto Cycle]** key

Use to process the master and make prints at one stroke. See ⇒ P.49 “Auto Cycle—Making Master And Prints At One Stroke”.

25. **[Proof]** key

Press to make proof prints.

26. **[Print]** key

Press to start printing.

Indicators

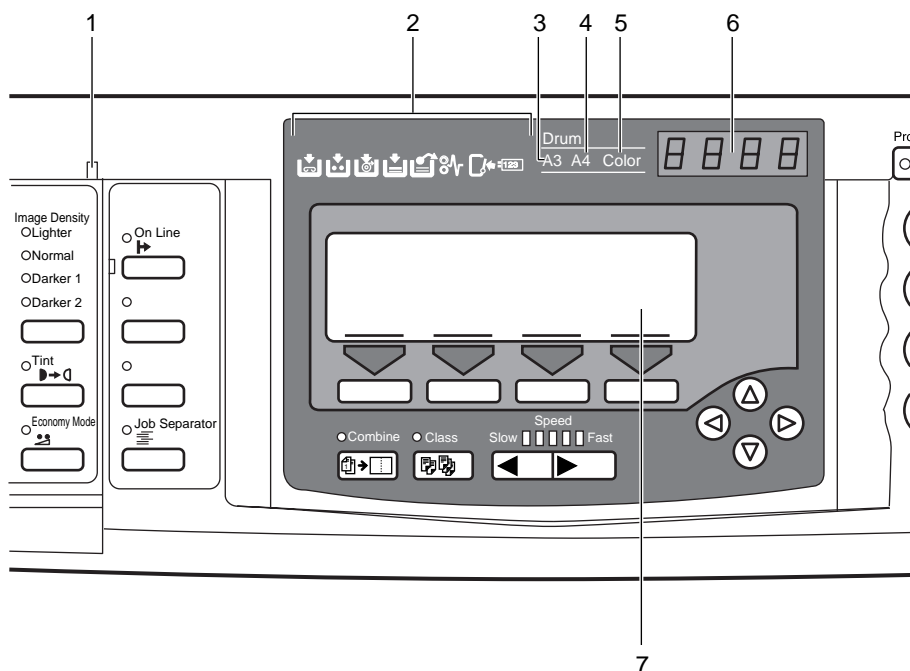

TPES012A

1. Special Feature indicator

This indicator is lit when you press keys under the flip-up cover.

2. Monitors

The monitors light up when a non-standard condition occurs within the machine. See ⇒ P.165 "If Your Machine Does Not Operate As You Want".

3. A3/11" × 17" Drum indicator

This indicator is lit when the A3, 11" × 17" drum unit is installed. See ⇒ P.90 "Changing The Drum Size".

4. A4/8¹/₂" × 11" Drum indicator

This indicator is lit when the A4, 8¹/₂" × 11" drum unit is installed. See ⇒ P.90 "Changing The Drum Size".

5. Color Drum indicator

This indicator is lit when the color drum unit is installed. See ⇒ P.87 "Color Printing Using The Optional Color Drum".

6. Counter

Displays the number of prints entered. While printing, it shows the number of prints remaining.

7. Panel Display

See ⇒ P.9 "Panel Display".

Panel Display

The panel display shows operational status, error messages, and function menus.

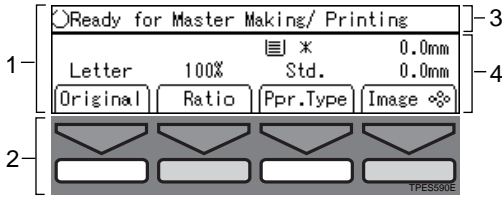

1. The function items for the selected function are displayed.

2. These keys correspond to the item on the display.

Press a relevant key to select a function.

- To move the selection to the left, press the [←] key.

- To move the selection to the right, press the [→] key.

3. Displays operational status or messages.

4. Displays items which can be selected or specified.

Important

- ❑ Do not apply a strong shock or force of about 30 N (about 3 kgf) or more to the panel display. Otherwise, the display might be damaged.

Note

- ❑ When you select or specify an item on the panel display, it is highlighted, ex. **Auto**. Keys appearing as a **OK** cannot be used.
- ❑ Common keys:

[OK]	Sets a selected function or entered value.
[Cancel]	Cancel a selected function or entered value and returns to the previous display.
[Prev.][Next]	When there are too many items to fit on the display, use these keys to move between pages.
[<] [>] [Δ] [▽] [←] [→]	Press to highlight the selection you wish to select.
[Select]	Sets a selected value.
[Exit]	Turns off the message panel display and returns to the previous display.

Display Panel Layout

The basic elements used on the display are shown below. Understanding their meaning helps you exploit this machine's features quickly and easily.

❖ Sample Display for Selecting the [Original] key

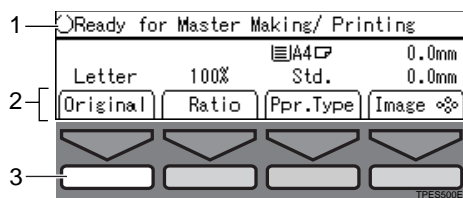

1. Operational status or message.
2. Available functions.
3. If you see a picture with a key whitened out, it means "Press this key".

↓ Press the [Original] key.

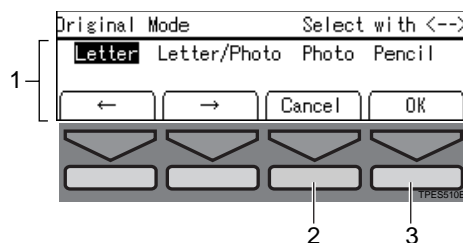





1. Available functions.
2. Cancels the settings and returns to the previous display.
3. Confirms the settings.

1. OPERATION

Printing Paper

The following types of print paper are not recommended for this machine.

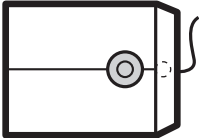
- Paper smaller than 70 mm × 148 mm, 2.8" × 5.9"
- Paper larger than 297 mm × 432 mm, 11.6" × 17.0"
- Paper heavier than 209.3 g/m², 55.6 lb
- Paper lighter than 47.1 g/m², 12.6 lb
- Roughly-cut paper
- Paper of different thickness in the same stack
- Envelopes heavier than 85 g/m², 22 lb.
- Folded, curled, creased, or damaged paper
- Torn paper
- Slippery paper
- Rough paper
- Paper with any kind of coating (such as carbon)
- Short grain paper
- Thin paper that has low stiffness
- The following types of envelopes

Envelopes with glue or gum	Envelopes with windows	Envelopes with round tags	Open envelopes
			 <p>Less than 150mm 6.0"</p> <p>Paper feed direction</p>

If you make a print on rough grain paper, the copy image might be blurred.

You can use A3 (297 × 420 mm) or 11" × 17" originals or printing paper. When you want to print the entire image of an A3, 11" × 17" original, select Reduce mode because the maximum print areas are as follows:

- Metric version: 290 × 409 mm, 11.4" × 16.1"
- Inch version: 290 × 419 mm, 11.4" × 16.4"

When you use A3, 11" × 17" and 209.3 g/m², 55.6 lb paper, slow the printing speed down to setting 1, 2, or 3.

⚠ Important

- ❑ Correct curls in the paper before setting it in the machine. When you cannot correct the paper curl, stack the paper with the curl face down. If paper is curled, it might wrap around the drum or stains might appear.

Do not store paper where it will be exposed to heat or direct sunlight.

Store on a flat surface.

Store paper where it will not curl or absorb moisture. Use paper soon after it is unpacked.

Only use paper where the leading edge has two right angle corners.

Originals

The following original sizes set on the exposure glass (contact glass) can be detected.

Metric version	A3☐, B4☐, A4☐☐, B5☐☐
Inch version	11" × 17"☐, 8 ¹ / ₂ " × 14"☐, 8 ¹ / ₂ " × 11"☐☐

Under the following conditions, the machine might not detect the original. In this case, select the original image area with the **[Edge Erase]** key. See ⇒ P.40 "Edge Erase—Erasing Edge Margins".

- When you use originals with index tabs.
- When you use OHP transparencies or translucent originals.
- When you use dark originals.
- When you use originals with solid images.
- When you use originals other than the sizes described above.

If you do not lift the platen cover more than 30 cm, 12" when you replace originals, the machine might not detect the original.

The maximum original size you can set on the exposure glass (contact glass) is 304.8 × 432 mm, 12" × 17".

If you use originals that have bold letters or solid images at the leading edges, you might get prints with dirty edges. In this case, set the original face down with the widest margin toward the paper delivery tray or raise the printing speed.

Set the original after correction fluid and ink have completely dried. Not taking this precaution could mark the exposure glass (contact glass) and cause marks to be printed.

Basically, set originals as shown below.

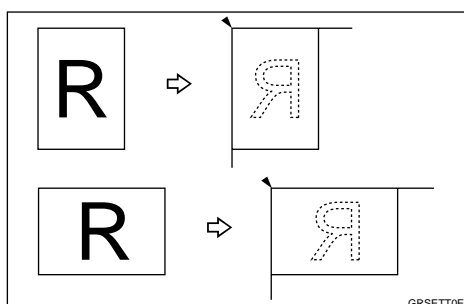

When you have an optional memory board and the original is set in a different direction from the print paper, the machine automatically rotates the original image by 90° to match the print paper direction.

The first 10 mm, 0.4", of the leading edge and the last 2 mm, 0.08", of the trailing edge cannot be printed. Make sure the leading edge margin is at least 10 mm, 0.4", and the trailing edge margin is at least 2 mm, 0.08".

1

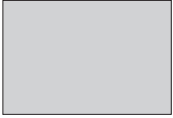
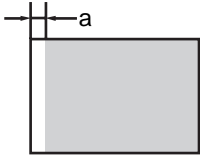
Original	Print
	

$a = 10 \text{ mm}, 0.4''$

Preparation For Printing

Loading Paper

- 1 Carefully open the paper feed tray.

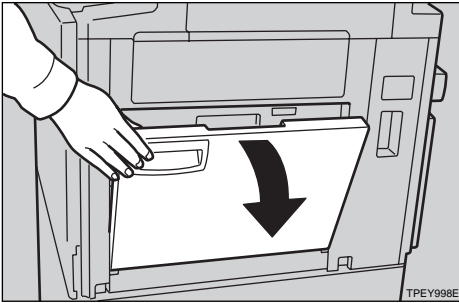

- 2 Lift the feed side/end plates.

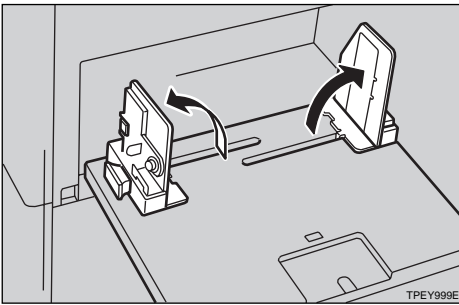

- 3 Grasp the side/end plate knob and adjust the side/end plates to match the paper size.

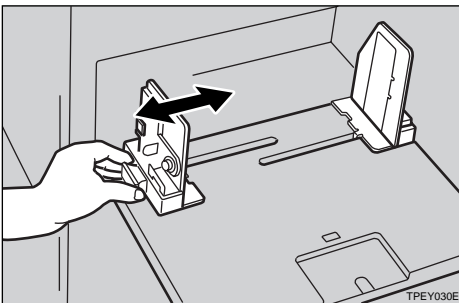

- 4 Place the paper on the paper feed tray.

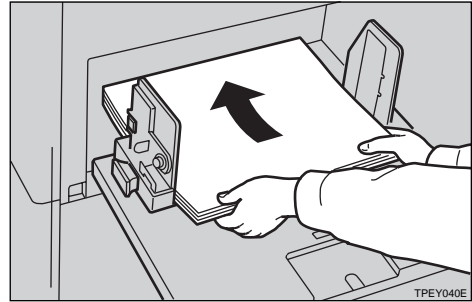

Note

- ❑ Correct the paper curl before setting the paper. If you cannot do so, stack the paper with the curl face down.

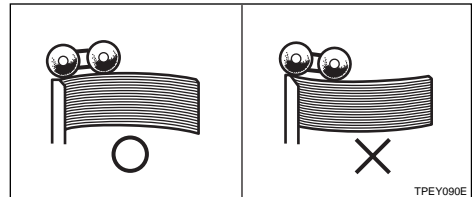

- 5 Make sure that the paper feed side/end plates make contact with the paper lightly.

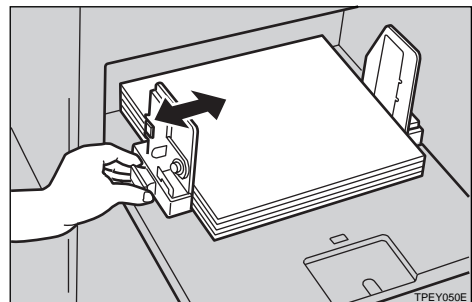

Note

- ❑ Make sure that the paper size and direction in the panel display correspond with the actual paper size and direction set on the paper feed tray.

Setting Up The Paper Delivery Tray

1

- 1 Grasp the end plate knob and move the paper delivery end plate to match the print paper size.

When you use A4, 8½" × 11"  or smaller paper

- 1 Adjust the end plate to match the paper size scale on the operation panel side.

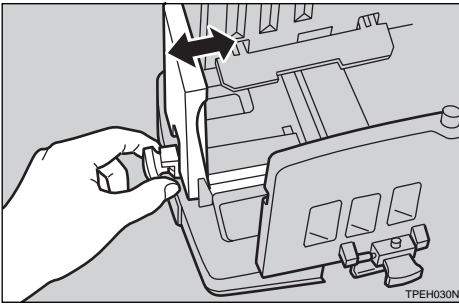

When you use B4, 8½" × 14"  or larger paper

- 1 Pull out the paper delivery tray until it stops.

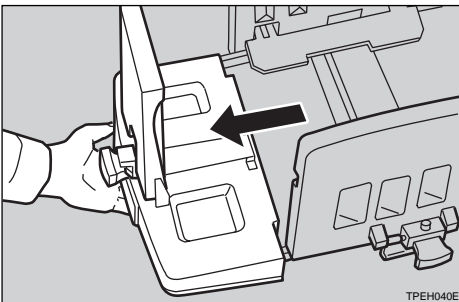

- 2 Adjust the end plate to match the paper size scale on the op-

posite side of the operation panel.

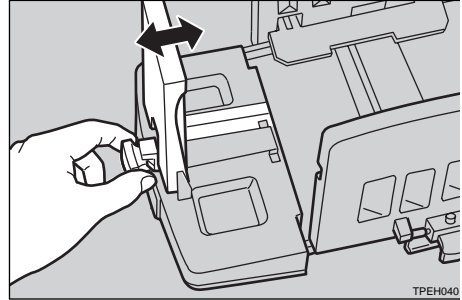

- 2 Grasp the side plate knobs and move the paper delivery side plates to match the print paper size.

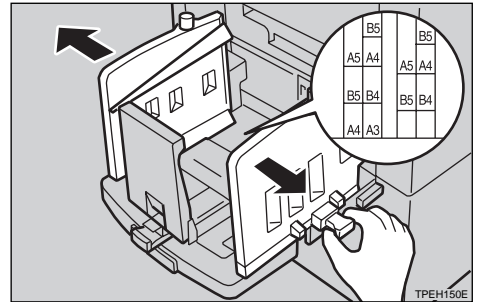

 **Note**

-  The inside of the side plates should match the paper size.

When you use thick paper (157 g/m² to 209.3 g/m², 42 lb to 55.6 lb)

- 1 Adjust the side plates to match the paper size scale on the main frame side.

When you use standard paper (47 g/m² to 128 g/m², 12.5 lb to 34 lb)

- 1 Adjust the side plates to match the paper size scale on the end plate side.

- 3** Lower or lift the paper alignment wings by turning the left and right knobs.

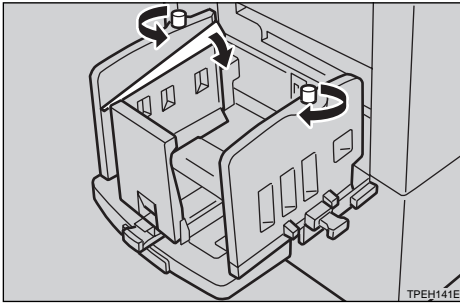

Note

- When the guides are up, you might not be able to load the unit to full capacity (1,000 sheets) depending on the paper you are using.
- Lift the paper alignment wings when B5 paper prints are curled.

When you use 81.4 g/m², 21.6 lb or thicker paper

- 1** Lower the paper alignment wings.

When you use 81.4 g/m², 21.6 lb or thinner and B5 or smaller paper

- 1** Lower the paper alignment wings.

When you use 81.4 g/m², 21.6 lb or thinner and A4, 8 1/2" × 11" or larger paper

- 1** Lift the paper alignment wings.

- 4** When you use A4, 8 1/2" × 11" paper, or B5 paper, swing out the trailing edge guides.

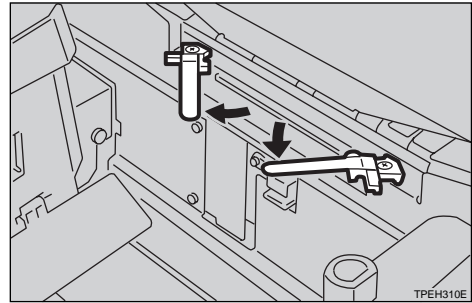

When you use A4, 8 1/2" × 11" paper

- 1** Swing out the guides as shown in the illustration.

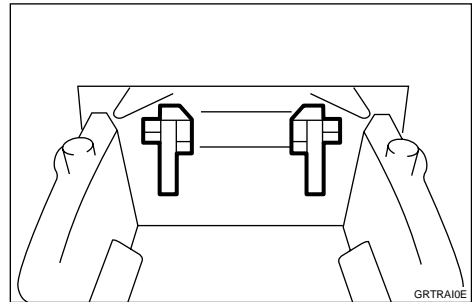

When you use B5 paper

- 1** Swing out the guides as shown in the illustration.

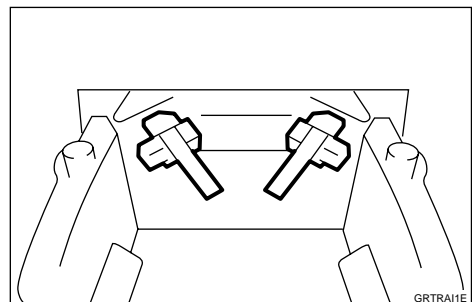

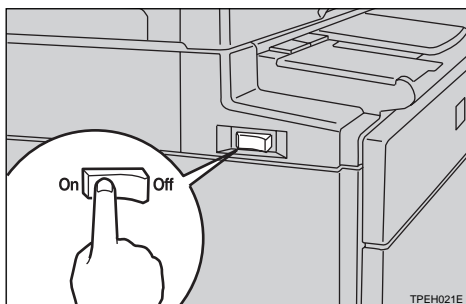
5 Turn on the main switch.**Note**

- You can have the machine display how much ink and master are left when you switch it on. See “User Tools—Ink/Master Left” in ⇒ P.139 “4. Mode Setting”.

User Codes

Preparation

You have to turn on User Code mode and register your user code with the user tools. You can register up to 20 user codes. See “Set User Code”, “Reg. User Code”, in ⇒ P.146 “6. Set User Code (s)”.

If the machine is set to use the User Code function, operators must input their user codes before the machine can be operated. The machine keeps count of the number of copies made under each user code. See “Set User Code”, “Reg. User Code”, in ⇒ P.146 “6. Set User Code (s)”.

Note

- When the machine is set for user codes, the machine will prompt you for your user codes when you turn the main switch on or when auto reset comes into effect.

1 Input your user code (4 digits) with the Number keys.

Please input user code.
then press # key.
User Code : ----

Note

- User codes are not displayed on the panel display.
- To change the number entered, press the **[Clear/Stop]** key and enter the new number.

2 Press the **[Enter]** key.

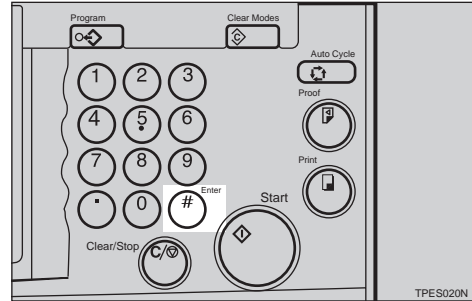

3 Make your prints.

4 To prevent others from making prints with your user code, hold the **[Clear Modes]** key, then press the **[Clear/Stop]** key.

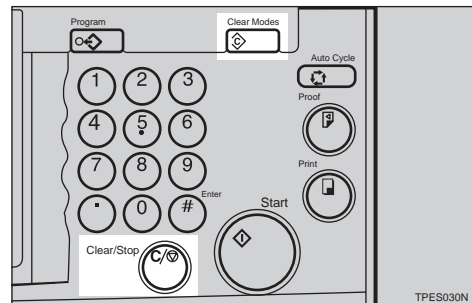

Standard Printing

1

- 1** Lift the platen cover.

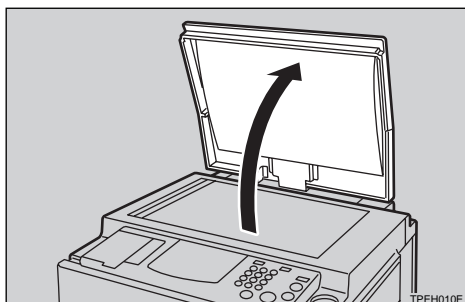

Note

- Be sure to lift the platen cover more than 30 cm, 12".

- 2** Set the original face down on the exposure glass (contact glass). The original should be aligned to the rear left corner.

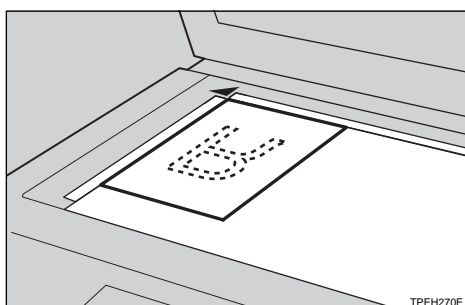

- 3** Lower the platen cover.

- 4** Select the paper type with the [Ppr. Type] key.

Reference

See ⇒ P.42 "Printing On Various Kinds Of Paper".

- 5** Enter the number of prints required with the Number keys.

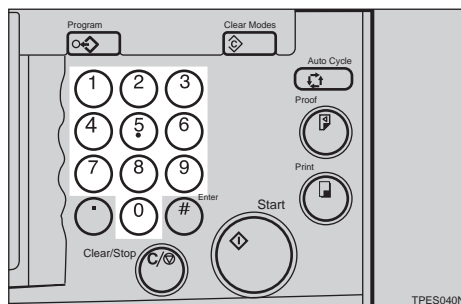

Note

- Up to 9999 prints can be entered at one time.
- To change the number entered, press the **[Clear/Stop]** key and enter the new number.

- 6** Press the **[Start]** key.

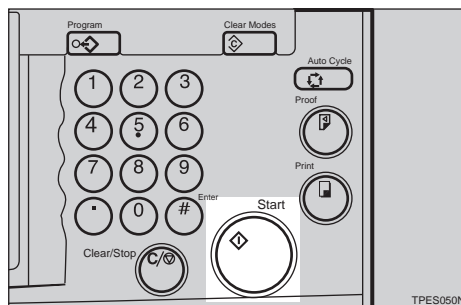

A trial print is delivered to the paper delivery tray.

- 7** Press the **[Proof]** key and check the image density and the image position of the proof print.

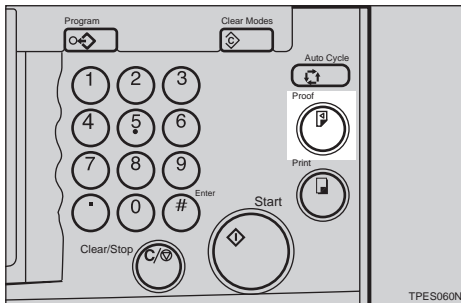

Note

- If the image position is not correct, adjust it using the **[Image ⌘]** key. See ⇒ P.25 "Adjusting Print Image Position".
- If the image density is slightly dark or light, adjust the image density using the **[Speed]** keys. See ⇒ P.26 "Adjusting Print Image Density".

- 8** Press the **[Print]** key.

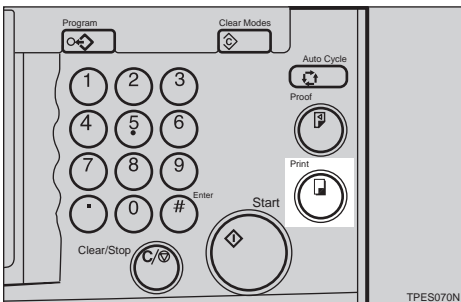

Note

- After printing is completed, the same number of prints is automatically set for the next job.
- To stop the machine during a multi-print run, press the **[Clear/Stop]** key.

- 9** Open the paper delivery side plate of the operation panel side.

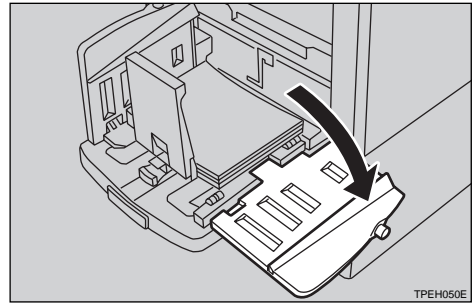

Note

- You cannot open the side plate on the opposite side.

- 10** Remove the prints from the paper delivery tray.

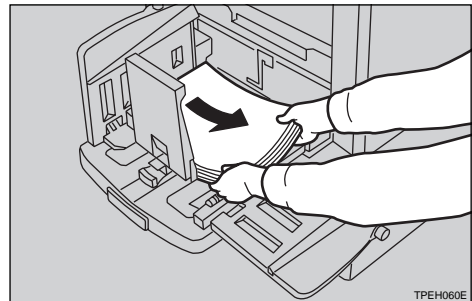

Note

- To return the machine to the initial condition after printing, press the **[Clear Modes]** key.

- 11** Close the paper delivery side plate.

Loading Paper On The Paper Feed Tray

1

The **Load Paper** indicator (📄) lights when the paper feed tray runs out of paper.

Replenishing Paper

1 Press the **[Clear/Stop]** key.

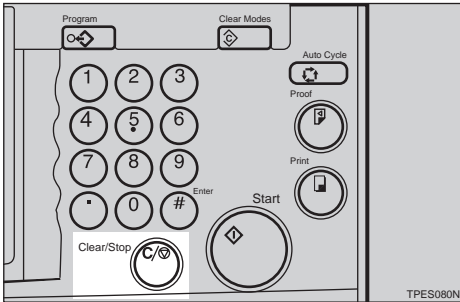

Note

- ❑ This step is necessary only if you want to pause a print run to replenish paper.

2 Press the **Paper Feed Tray Down** key.

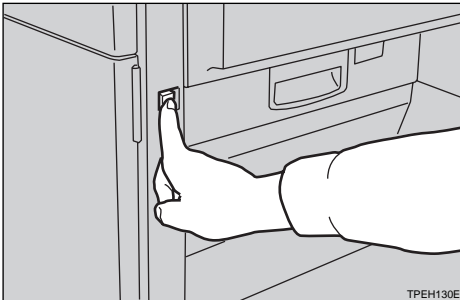

Note

- ❑ The paper feed tray will lower without the key being pressed when printing paper runs out.
- ❑ The top sheet might remain between the feed rollers. In this case, remove the top sheet.

3 Load paper on the paper feed tray.

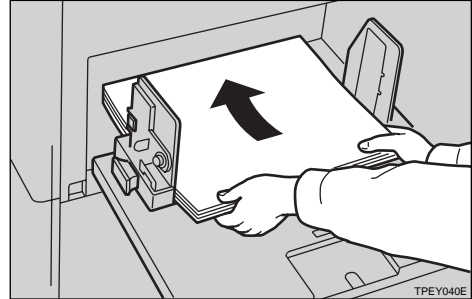

Note

- ❑ If you wish to set a different kind of paper, select the appropriate paper type with the **[Ppr. Type]** key. See ⇒ P.42 "Printing On Various Kinds Of Paper".
- ❑ Release the pads of the feed side/end plates before loading paper. Reset the pads after paper is set.
- ❑ Correct paper curl before setting the paper.

4 Press the **[Print]** key to resume printing.

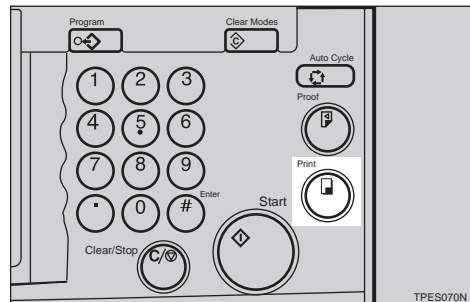

Changing The Paper Size

- 1 Remove the paper from the paper feed tray.

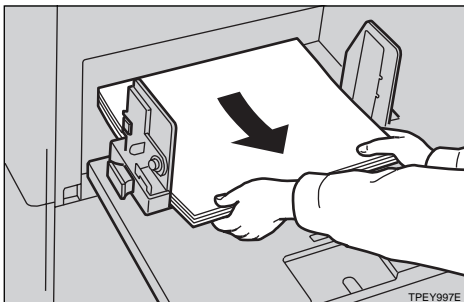

The paper feed tray will lower.

- 2 Grasp the side/end plate knob and adjust the paper feed side/end plates to match the paper size.

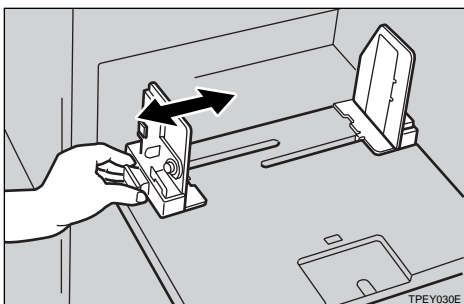

- 3 Place the paper on the paper feed tray.

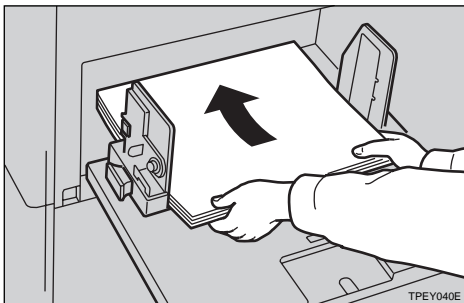

Note

- ❑ Correct any paper curl before setting the paper.

- ❑ Make sure that the side/end plates touch the paper lightly.
- ❑ Make sure that the paper size and direction in the panel display correspond with the actual paper size and direction set on the paper feed tray.
- ❑ If you set a different kind of paper, do not forget to select the appropriate paper type with the **[Ppr. Type]** key. See ⇒ P.42 "Printing On Various Kinds Of Paper".

- 4 Adjust the paper delivery side plates and if necessary, pull out or in the paper delivery tray and adjust the end plate. See ⇒ P.16 "Setting Up The Paper Delivery Tray".

Closing The Paper Feed And Paper Delivery Trays

1

1 Remove the paper from the paper feed tray.

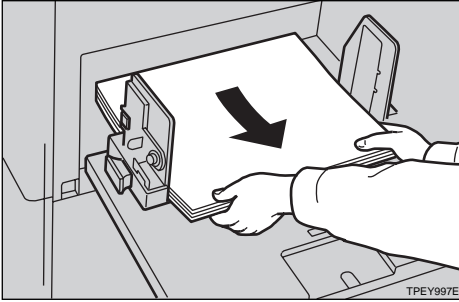

The paper feed tray will lower.

2 Turn off the main switch.

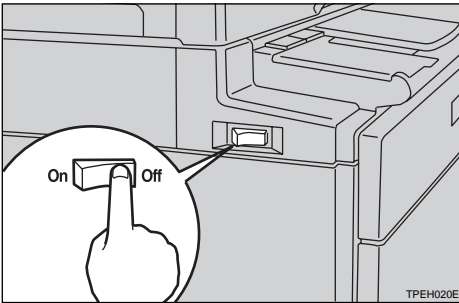

3 Adjust the side/end plates to match A4 paper and lower them.

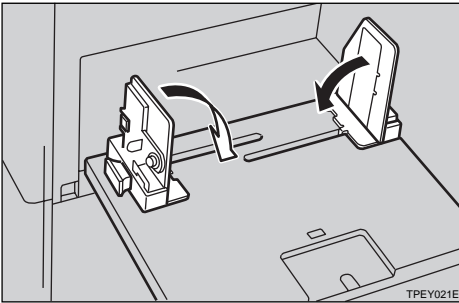

4 Close the paper feed tray.

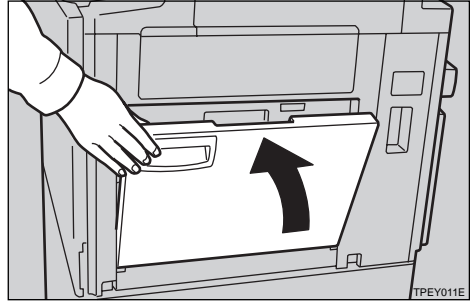

5 Push in the paper delivery tray, if necessary.

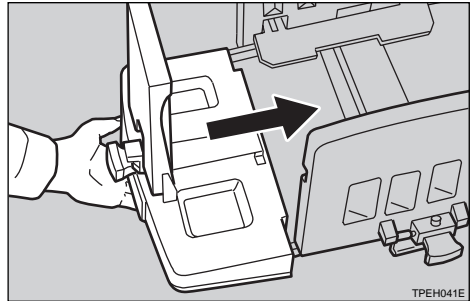

Adjusting Print Image Position

You can adjust the print image position to suit your needs.

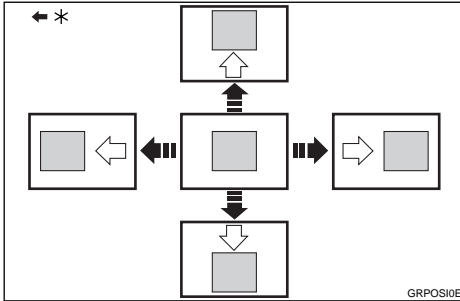

*...Paper feed direction

1 Press the [Image ] key.

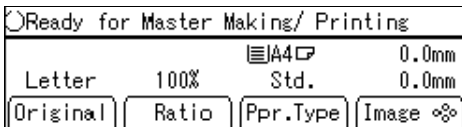

Note

- You can skip step **1** and adjust the image position directly by pressing the [◀], [▶], [▲], and [▼] keys.

2 Adjust image position using the [◀], [▶], [▲], and [▼] keys.

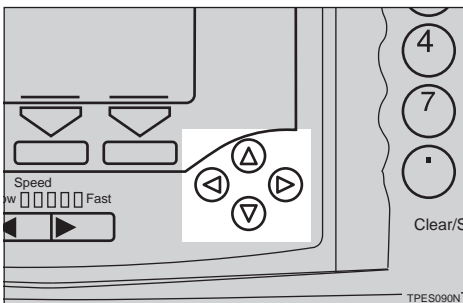

Note

- When you shift the image forwards, leave a 10 mm, 0.4" margin at the leading edge. If there is no margin, paper might wrap around the drum and cause a misfeed.
- The [◀] and [▶] keys shift the image up to 15 mm, 0.6" each way and the image is shifted about 0.5 mm, 0.02" each time they are pressed.
- The [▲] and [▼] keys shift the image up to 10 mm, 0.4" each way and the image is shifted about 0.5 mm, 0.02" each time they are pressed.

3 Press the [OK] key.

4 Press the [Proof] key to check the image position.

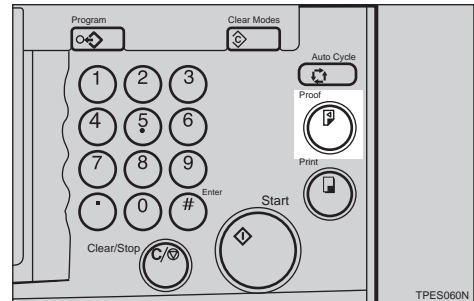

Adjusting Print Image Density

You can adjust the print image density to suit your needs. There are two ways to do this:

- ❖ **Before Making A Master**
Use the **[Image Density]** key.
- ❖ **After Making A Master**
Use the **[Speed]** keys.

Before Making A Master

1 Press the **[Image Density]** key to adjust the image density.

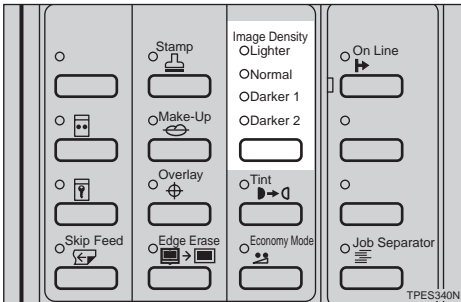

2 Press the **[Start]** key.

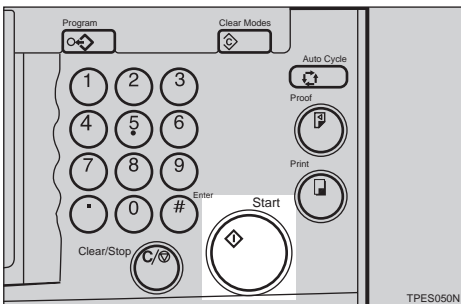

After Making A Master

1 To increase the image density, press the **[◀]** key. To reduce the image density, press the **[▶]** key.

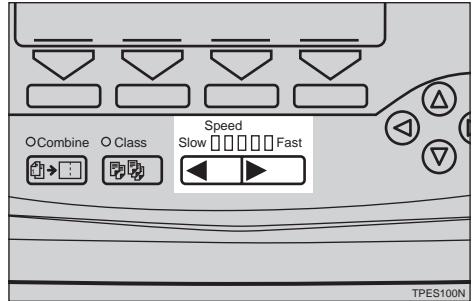

- Note**
- ❑ The faster the printing speed becomes, the lighter the printing density is. If you want darker prints, decrease the printing speed.

Tint Mode—Halftone Printing

Use this function to print tinted images.

1

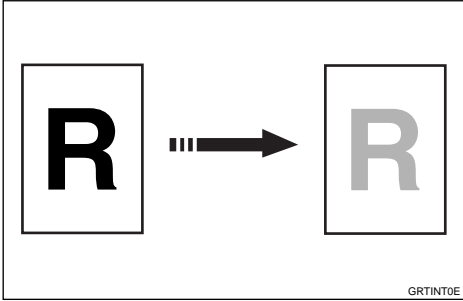

1 Press the **[Tint]** key.

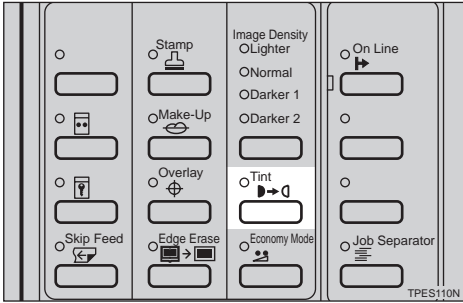

2 Press the **[Start]** key.

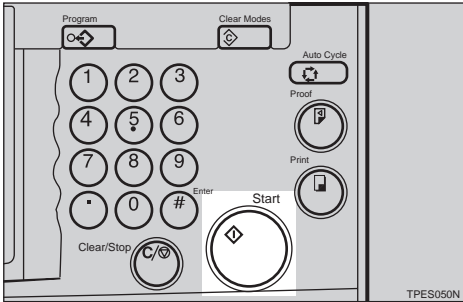

Changing The Printing Speed

1

Use the **[Speed]** keys to adjust the printing speed. The relationship between printing speed and print quality depends on the type of paper you use.

1 Press the **[▶]** key to increase the speed and press the **[◀]** key to reduce the speed.

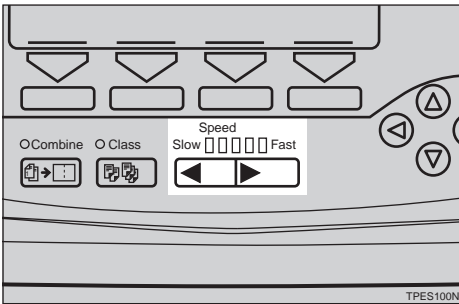

Note

- The following speeds are available:
 - Setting 1:
60 sheets/minute
 - Setting 2:
75 sheets/minute
 - Setting 3:
90 sheets/minute
 - Setting 4:
105 sheets/minute
 - Setting 5:
120 sheets/minute
- The default is 90 sheets/minute.
- The faster the printing speed becomes, the lighter the printing density is, and vice versa.
- When the machine is used in low temperature conditions, the image density might decrease. In this case, slow the printing speed down to setting 1 or 2.

Stopping The Machine During A Multi-print Run

1

When You Want To Stop The Machine During A Multi-print Run And Print A Different Original

- 1 Press the **[Clear/Stop]** key.

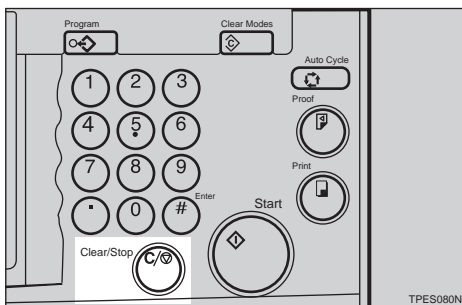

- 2 Set the new original.

- 3 Enter the number of prints and press the **[Start]** key.

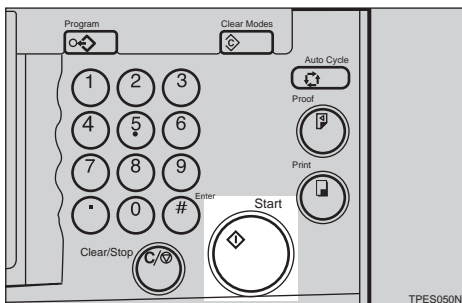

When You Want To Change The Number Of Prints Entered Or Check The Completed Prints

- 1 Press the **[Clear/Stop]** key.

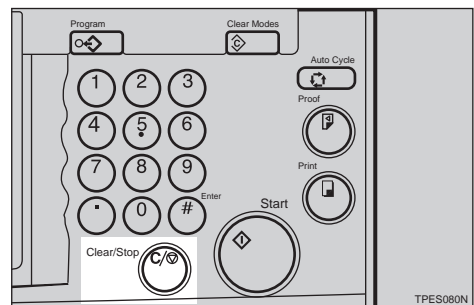

- 2 Change the number of prints or check the completed prints.

Note

- When you change the number of prints, you can re-enter the number with the Number keys after pressing the **[Clear/Stop]** key.

- 3 Press the **[Print]** key.

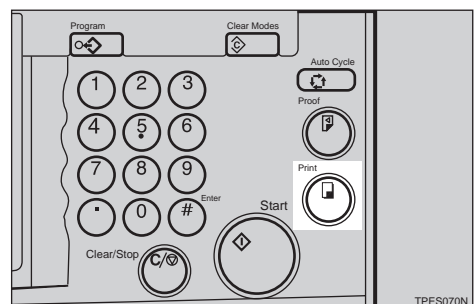

Preset Reduce/Enlarge—Reducing And Enlarging Using Preset Ratios

1

You can select a preset ratio for printing.

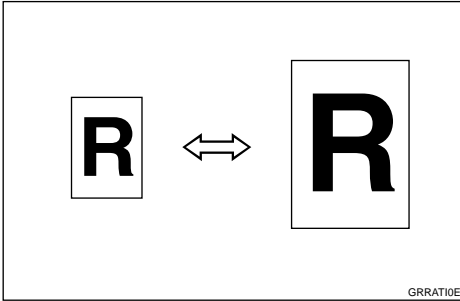

Note

- The leading edge of the print image does not shift when a print image is made with this function.

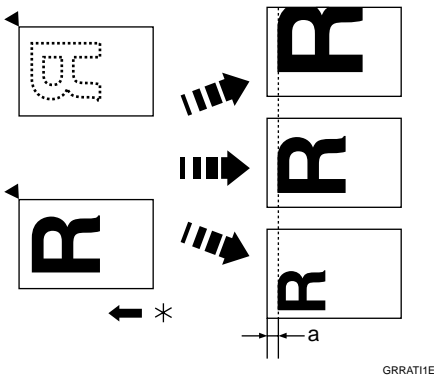

*...Paper feed direction

a=10 mm, 0.4"

- You can select one of 7 preset ratios (3 enlargement ratios, 4 reduction ratios).
- You can select a ratio regardless of the size of an original or printing paper. With some ratios, parts of the image might not be printed or margins will appear on prints.

- You can change the fixed reproduction ratio with the user tools. See "Reproduction Ratio" in ⇒ P.148 "3-4 Reproduction Ratio".
- Prints can be reduced or enlarged as follows:

❖ Metric version

Ratio (%)	Original → Print paper size
141	A4 → A3, A5 → A4, B5 → B4, B6 → B5
122	A4 → B4, A5 → B5
115	B4 → A3, B5 → A4, B6 → A5
93	
87	A3 → B4, A4 → B5
82	B4 → A4, B5 → A5
71	A3 → A4, A4 → A5, B4 → B5

❖ Inch version

Ratio (%)	Original → Print paper size
155	5 1/2" × 8 1/2" → 8 1/2" × 14"
129	8 1/2" × 11" → 11" × 17", 5 1/2" × 8 1/2" → 8 1/2" × 11"
121	8 1/2" × 14" → 11" × 17"
93	
77	8 1/2" × 14" → 8 1/2" × 11"
74	11" × 15" → 8 1/2" × 11"
65	11" × 17" → 8 1/2" × 11", 8 1/2" × 11" → 5 1/2" × 8 1/2"

1 Press the [Ratio] key.

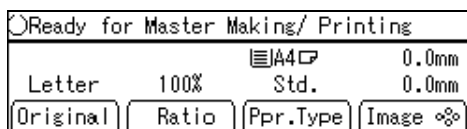

2 Select the desired ratio with the [←], [→], [◀], or [▶] key.

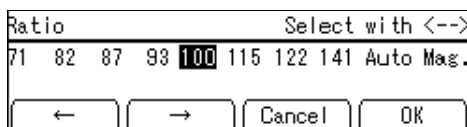

3 Press the [OK] key.

4 Make sure that the original and the print paper are the correct size.

5 Set your original on the exposure glass (contact glass) or in the optional document feeder.

6 Press the [Start] key.

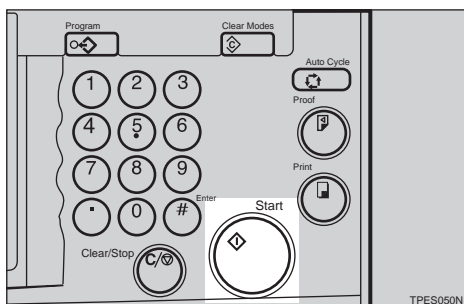

7 Check the image position of the trial or proof print.

Note

- ❑ If the image position is not correct, adjust it using the [Image] key (see ⇒ P.25 “Adjusting Print Image Position”).

8 Make your prints.

Auto Magnification Selection—Having The Machine Choose The Reproduction Ratios

1

The machine can choose an appropriate reproduction ratio based on the paper and original sizes you use.

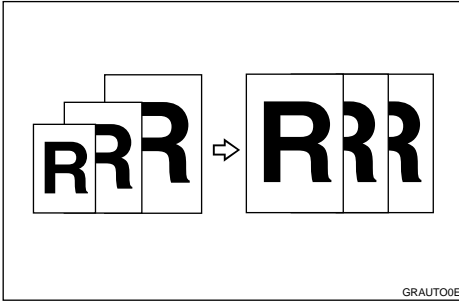

Note

- ❑ You can change the reproduction ratio from 50 % to 200 % when you set an original on the exposure glass (contact glass).
- ❑ You can change the reproduction ratio from 50 % to 155 % when you set an originals in the optional document feeder.
- ❑ The paper and the original sizes that can be used in this function and the reproduction ratio selected depending on the original and paper sizes are as follows:

◆ Metric version

Original Paper	A3☐	B4☐	A4☐	A4☑	B5☐	B5☑	A5☐ *2	A5☑ *2
A3☐	100 %	115 %	141 %	--	163 %	--	--	--
B4☐	87 %	100 %	122 %	--	141 %	--	--	--
A4☐	71 %	82 %	100 %	100 % *1	115 %	115 % *1	141 %	141 % *1
A4☑	71 % *1	82 % *1	100 % *1	100 %	115 % *1	115 %	141 % *1	141 %
B5☐	61 %	71 %	87 %	87 % *1	100 %	100 % *1	122 %	122 % *1
B5☑	61 % *1	71 % *1	87 % *1	87 %	100 % *1	100 %	122 % *1	122 %
A5☐	50 %	50 %	71 %	71 % *1	82 %	82 % *1	100 %	100 % *1
B6☐	--	50 %	61 %	61 % *1	71 %	71 % *1	87 %	87 % *1

*1 When your machine is equipped with the optional memory board, the machine automatically rotates the original image by 90° to match the paper direction and selects the proper reproduction ratio. See ⇒ P.91 "Image Rotation—Rotating Original Images".

*2 Set these originals in the optional document feeder.

❖ **Inch version**

Original \ Paper	11" × 17"	8 1/2" × 14"	8 1/2" × 11"	8 1/2" × 11"	8 1/2" × 5 1/2"	8 1/2" × 5 1/2"
11" × 17"	100 %	121 %	129 %	--	200 % *2	--
8 1/2" × 14"	77 %	100 %	--	--	155 %	--
8 1/2" × 11"	65 %	77 %	100 %	100 % *1	129 %	129 % *1
8 1/2" × 11"	65 % *1	77 % *1	100 % *1	100 %	129 % *1	129 %
8 1/2" × 5 1/2"	50 %	61%	65 %	65 % *1	100 %	100 % *1

*1 When your machine is equipped with the optional memory board, the machine automatically rotates the original image by 90° to match the paper direction and selects the proper reproduction ratio. See ⇒ P.91 "Image Rotation—Rotating Original Images".

*2 Set these originals in the optional document feeder.

Depending on the original type you use, the proper reproduction ratio might not be selected. See ⇒ P.13 "Originals" and ⇒ P.81 "Originals".

1 Set your original on the exposure glass (contact glass) or in the optional document feeder.

2 Press the [Ratio] key.

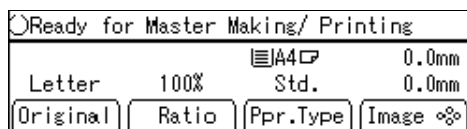

3 Select [Auto] with the [→] or [▷] key.

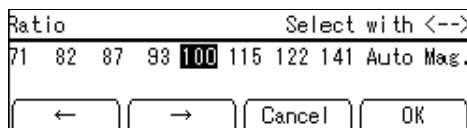

4 Press the [OK] key.

5 Press the **[Start]** key.

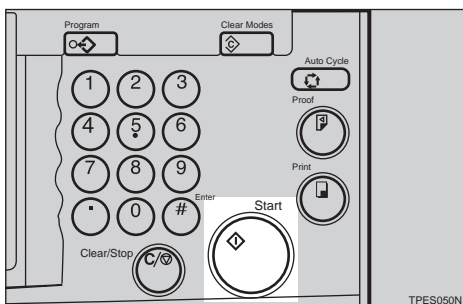

6 Check the image position of the trial or proof print.

 **Note**

- If the image position is not correct, adjust it using the **[Image ⚙️]** keys (See ⇒ P.25 "Adjusting Print Image Position").

Zoom—Reducing And Enlarging In 1 % Steps

You can change the reproduction ratio in 1 % steps.

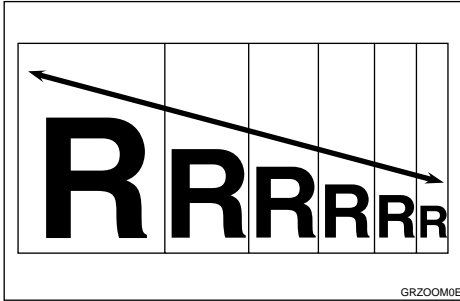

Note

- You can change the reproduction ratio from 50 % to 200 % when you set an original on the exposure glass (contact glass).
- You can change the reproduction ratio from 50 % to 155 % when you set originals in the optional document feeder.

1 Press the [Ratio] key.

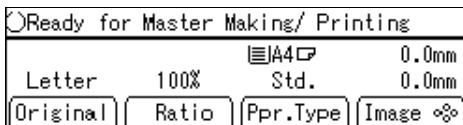

Note

- To select a custom ratio, select the closest ratio with the [←], [→], [◀], or [▶] key. Then press the [△] or [▽] key and go to step 6.

2 Select [Mag.] with the [→] or [▶] key.

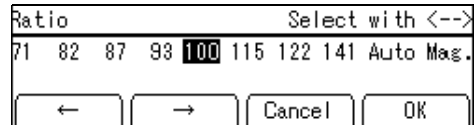

3 Press the [OK] key.

4 Make sure that [Zoom] is selected.

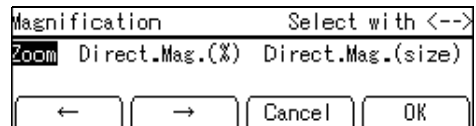

5 Press the [OK] key.

6 Enter the desired reproduction ratio.

Note

- To change the value entered, press the [Clear/Stop] key and enter the new value.

Using the [←], [→], [◀], or [▶] key

1 Adjust the ratio with the [←], [→], [◀], or [▶] key.

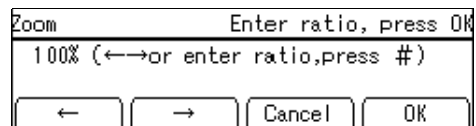

Using the number keys

- 1 Enter the ratio with the Number keys.

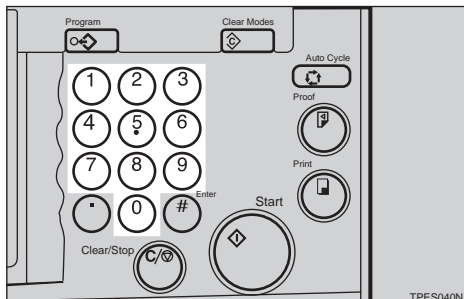

- 2 Press the [Enter] key.

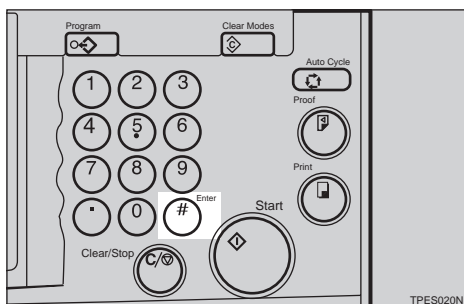

- 7 Press the [OK] key.
- 8 Make sure that the original and the print paper are the correct size.
- 9 Set your original on the exposure glass (contact glass) or in the optional document feeder.
- 10 Press the [Start] key.

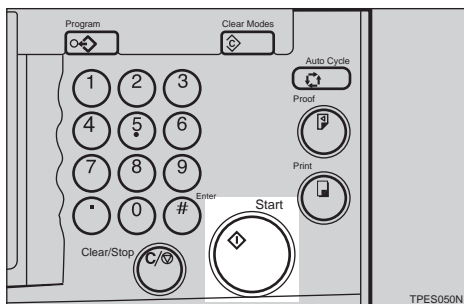

- 11 Check the image position of the trial or proof print.

Note

- If the image position is not correct, adjust it using the [Image] key (see ⇒ P.25 "Adjusting Print Image Position").

- 12 Make your prints.

Directional Magnification—Stretching And Squeezing The Image In 1 % Steps

Prints can be reduced or enlarged at different reproduction ratios horizontally and vertically. There are two ways to use this feature:

❖ Enter The Reproduction Ratios

Adjust the reproduction ratio manually.

❖ Enter The Dimensions Of The Original And Print Paper

Have the machine automatically select the proper reproduction ratio.

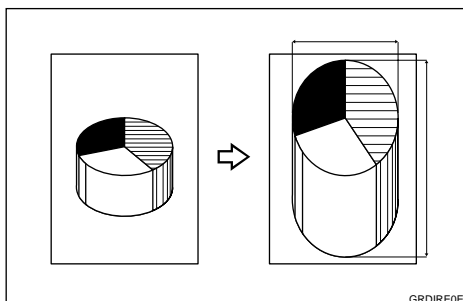

Note

- ❑ You can change the reproduction ratio from 50 % to 200 % when you set an original on the exposure glass (contact glass).
- ❑ You can change the reproduction ratio from 50 % to 155 % when you set originals in the optional document feeder.

Entering The Reproduction Ratios

1 Press the [Ratio] key.

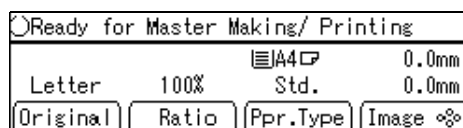

2 Select [Mag.] with the [→] or [▷] key.

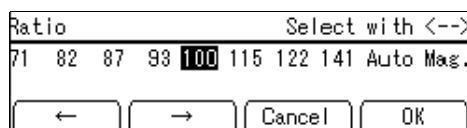

3 Press the [OK] key.

4 Select [Direct. Mag. (%)] with the [→] or [▷] key.

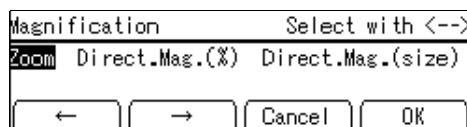

5 Press the [OK] key.

6 Enter the vertical and horizontal ratio.

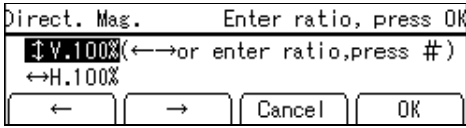

Note

- To change the value entered, press the **[Clear/Stop]** key and enter the new value.

Adjusting ratios with the **[←]**, **[→]**, **[◀]**, or **[▶]** key

- Adjust the vertical ratio with the **[←]**, **[→]**, **[◀]**, or **[▶]** key.
- Press the **[▽]** key.
- Adjust the horizontal ratio with the **[←]**, **[→]**, **[◀]**, or **[▶]** key.

Entering the ratios with the number keys

- Enter the vertical ratio with the Number keys.
- Press the **[Enter]** key.
- Enter the horizontal ratio with the Number keys.
- Press the **[Enter]** key.

7 Press the **[OK]** key.

8 Make sure that the original and the print paper are the correct size.

9 Set your original on the exposure glass (contact glass) or in the optional document feeder.

10 Press the **[Start]** key.

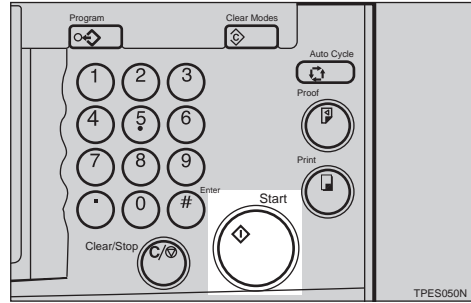

11 Check the image position of the trial or proof print.

Note

- If the image position is not correct, adjust it using the **[Image ⦿]** key (see ⇒ P.25 "Adjusting Print Image Position").

12 Make your prints.

Entering The Dimensions Of The Original And Print Paper

1 Press the **[Ratio]** key.

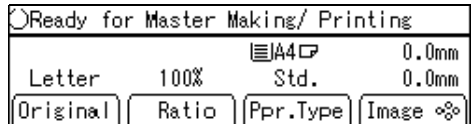

2 Select **[Mag.]** with the **[→]** or **[▶]** key.

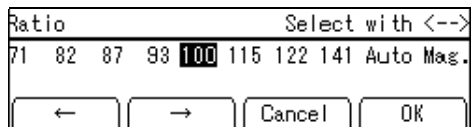

3 Press the [OK] key.

4 Select [Direct. Mag. (size)] with the [→] or [▷] key.

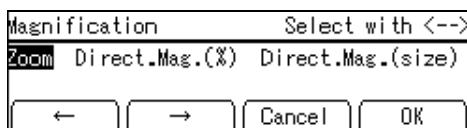

5 Press the [OK] key.

6 Enter the vertical original size with the Number keys and press the [Enter] key.

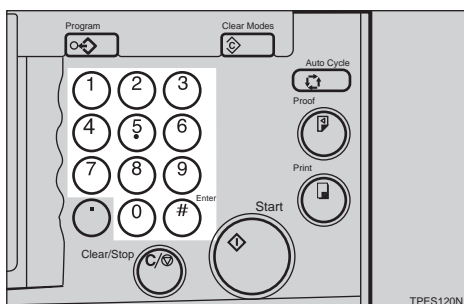

Note

- To change the value entered, press the [Clear/Stop] key and enter the new value.
- Up to 999 mm, 99.9" can be entered.

7 Enter the vertical print size with the Number keys and press the [Enter] key.

8 Enter the horizontal original size with the Number keys and press the [Enter] key.

9 Enter the horizontal print size with the Number keys.

10 Press the [OK] key.

The machine will select proper reproduction ratios for vertical and horizontal directions.

11 Make sure that the original and the print paper are the correct size.

12 Set your original on the exposure glass (contact glass) or in the optional document feeder.

13 Press the [Start] key.

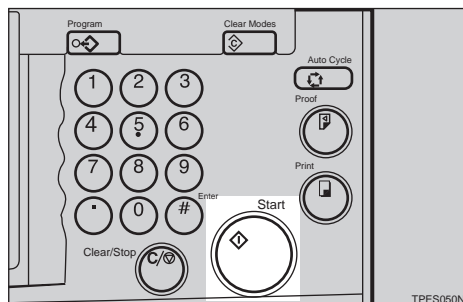

14 Check the image position of the trial or proof print.

Note

- If the image position is not correct, adjust it using the [Image ⦿] key (see ⇒ P.25 "Adjusting Print Image Position").

15 Make your prints.

Edge Erase—Erasing Edge Margins

1

This function erases all four sides of the original image.

❖ Using Edge Erase mode

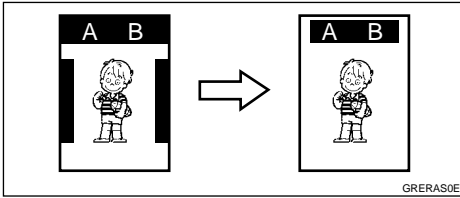

❖ When not using Edge Erase mode

When printing from thick books, or similar originals, the binding margin at the center and the edges might appear on prints. The machine erases these margins automatically. If you do not use Edge Erase mode using the following kind of originals, the images to be printed might be also erased.

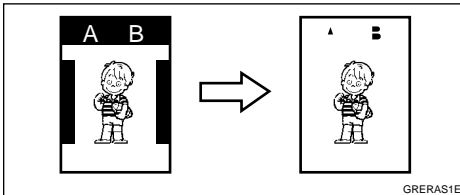

Note

You can adjust the erased margins with the user tools. The default is 2 mm, 0.1". See ⇒ P.150 "3-9 Margin Erase Area".

1 Set your original on the exposure glass (contact glass) or in the optional document feeder.

2 Enter the number of prints required with the Number keys.

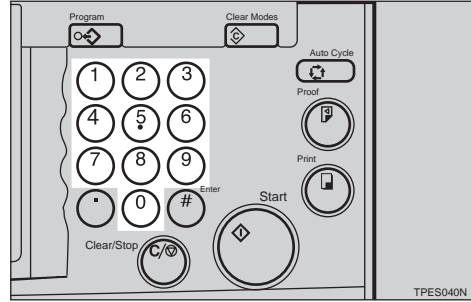

3 Press the [Edge Erase] key.

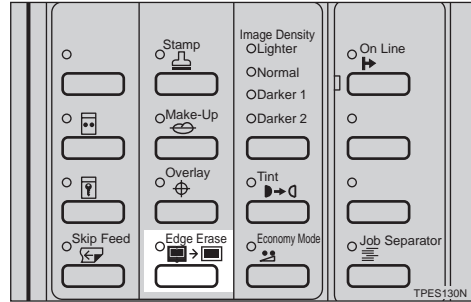

4 Select the original size and direction you use with the [←], [→], [<], [>], [Δ], or [▽] key.

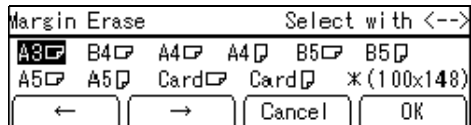

5 Press the [OK] key.



6 Press the **[Start]** key.

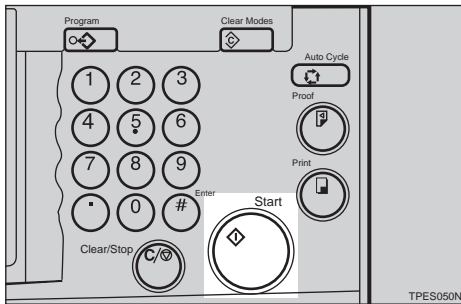

7 Check the image position of the trial or proof print.

Note

- If the image position is not correct, adjust it using the **[Image ⌘]** key (see ⇒ P.25 “Adjusting Print Image Position”).

8 Make your prints.

Printing On Various Kinds Of Paper

1

Printing On Thick Paper

When you make prints on thick (157 to 209.3 g/m², 42 to 55.6 lb) paper, perform the following steps.

1 Press the [Ppr. Type] key.



2 Select [Thick] with the [→] or [▷] key.



3 Press the [OK] key.

4 Adjust the paper delivery side plates to match the paper size scale on the main frame side.

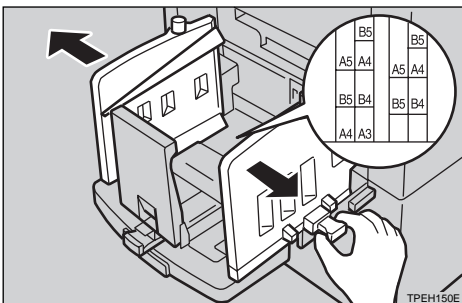

Note

- If necessary, lower the paper alignment wings. See ⇒ P.15 "Preparation For Printing".

Printing On Thin Paper

When you make prints on thin (47.1 g/m², 12.5 lb) paper, perform the following steps.

1 Press the [Ppr. Type] key.

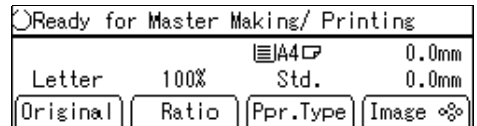

2 Make sure that [Std.] is selected.

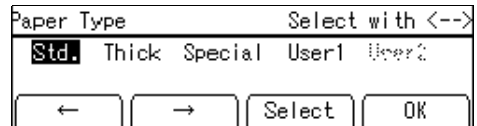

3 Press the [OK] key.

4 Adjust the paper delivery side plates to match the paper size scale on the end plate side.

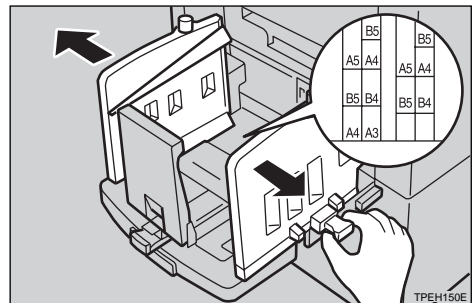

Note

- If necessary, lower or lift the paper alignment wings. See ⇒ P.15 "Preparation For Printing".

5 Set the side pads (move the side pad levers to as shown).

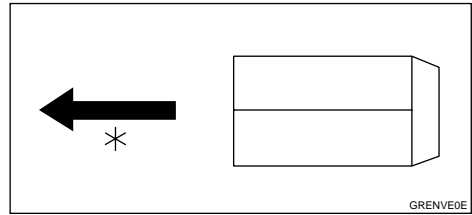
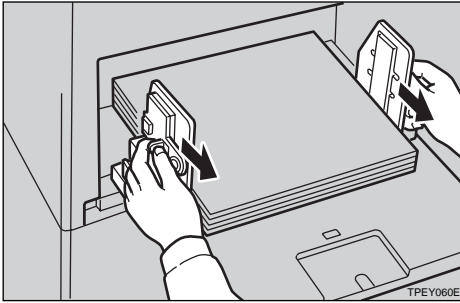

*: Paper feed direction

Note

- When you use envelopes, the paper feed tray capacity is about 150 sheets (85 g/m², 22 lb) or less than 105 mm, 4.1".

5 If your envelopes do not feed in well, lift the paper feed tray a little and bring it down so that it slants up slightly.

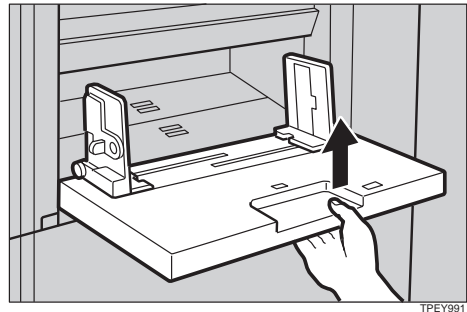

Printing On Envelopes

1 Press the [Ppr. Type] key.

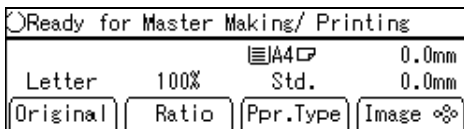

2 Select [Special] with the [←], [→], [◀], or [▶] key.

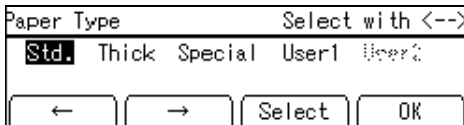

3 Press the [OK] key.

4 Place the envelopes on the paper feed tray as shown in the illustration.

Printing On Special Kinds Of Paper

Preparation

To use this function, you have to register the special paper type in [User 1] or [User 2] with the user tools. See "Type of Paper" in⇒ P.137 "3. Initial Setting".

1

1 Press the [Ppr. Type] key.



2 Select [User 1] or [User 2] with the [←], [→], [◀], or [▶] key.



3 Press the [OK] key.

To prevent paper misfeeds:

If paper misfeeds occur frequently even if you select the proper paper type, follow the steps below.

① Press the [Ppr. Type] key.

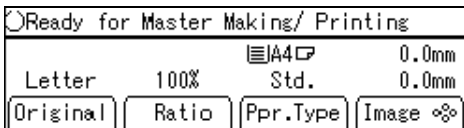

② Select one of the paper types with the [←], [→], [◀], or [▶] key.



③ Press the [Select] key.

④ Select the paper misfeed condition with the [◀], [▶], [▲], or [▼] key.

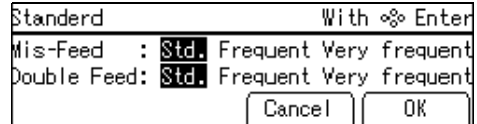

⑤ Press the [OK] key.

If the paper misfeeds occur frequently in the paper exit section even if you use standard or thin paper and select the [Std.], do the following:

① Set the wing guide to the "Down" position with the user tools. See "Deflector Angle" in ⇒ P.139 "4. Mode Setting".

When A4 – B5, 8¹/₂" × 11" thick paper is not delivered properly to the paper delivery tray, do the following:

① Set the wing guide to the "Up" position with the user tools. See "Deflector Angle" in ⇒ P.139 "4. Mode Setting".

Selecting A Mode To Match Your Original

Select one of the following four modes to match your originals:

❖ **Photo mode**

Delicate tones of photographs and pictures can be reproduced with this mode.

❖ **Letter mode**

Select this mode when your originals contain only letters (no pictures).

❖ **Letter/Photo mode**

Select this mode when your originals contain photographs or pictures with letters.

❖ **Pencil mode**

Select this mode when your originals are written in pencil.

 **Note**

- ❑ When using Photo mode to print originals with both text and photographs, the text will appear lighter. To avoid this, select Letter/Photo mode. Alternatively, use the optional Make-up function to specify Letter mode for text areas and Photo mode for photograph areas.

Photo Mode Printing

1 Press the [Original] key.

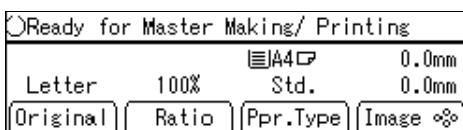

2 Select [Photo] with the [→] or [▷] key.



3 Press the [OK] key.

4 Adjust the screen image with the [←], [→], [◀], or [▷] key.

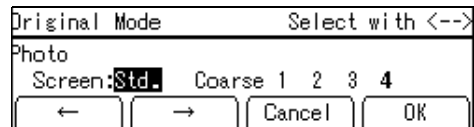

 **Note**

- ❑ Four coarseness settings are available:
 - Setting 4: coarsest
 - Setting 3: coarser than setting 2
 - Setting 2: coarser than setting 1
 - Setting 1: coarser than the standard setting

5 Press the [OK] key.

- 6** Adjust the lightness with the [←], [→], [◀], or [▶] key.

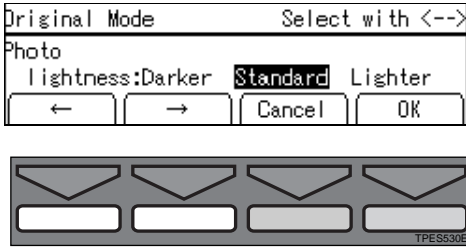

- 7** Press the [OK] key.
- 8** Set your original on the exposure glass (contact glass) or in the optional document feeder.
- 9** Press the [Start] key.

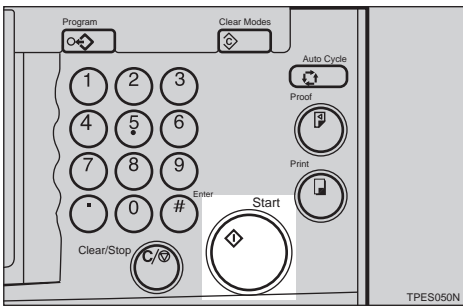

- 10** Check the image position of the trial or proof print.

Note

- If the image position is not correct, adjust it using the [Image ⚙️] key (see ⇒ P.25 "Adjusting Print Image Position").

- 11** Make your prints.

Letter/Photo Mode Printing

- 1** Press the [Original] key.

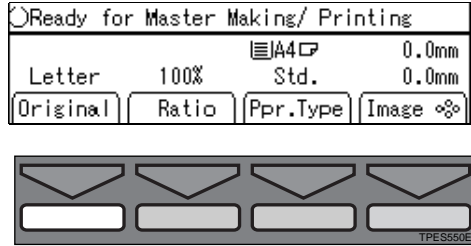

- 2** Select [Letter/Photo] with the [→] or [▶] key.

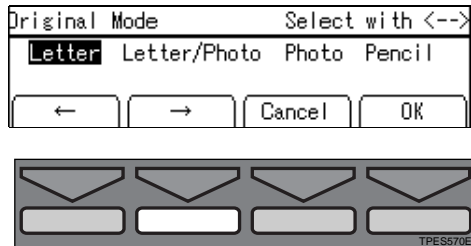

- 3** Press the [OK] key.

- 4** Adjust the lightness with the [←], [→], [◀], or [▶] key.

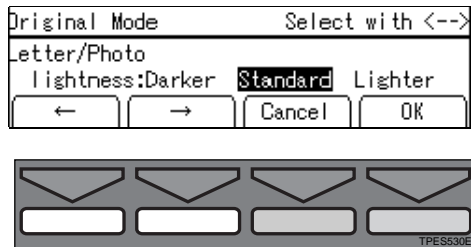

- 5** Press the [OK] key.

- 6** Set your original on the exposure glass (contact glass) or in the optional document feeder.

7 Press the **[Start]** key.

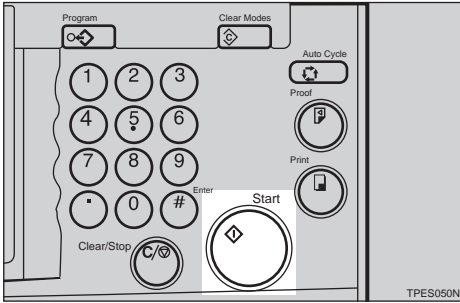

8 Check the image position of the trial or proof print.

Note

- If the image position is not correct, adjust it using the **[Image ⚙️]** key (see ⇒ P.25 “Adjusting Print Image Position”).

9 Make your prints.

Pencil Mode Printing

Note

- Originals written in pencil should be set on the exposure glass (contact glass).

1 Press the **[Original]** key.

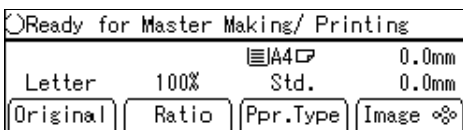

2 Select **[Pencil]** with the **[←]** or **[<]** key.



3 Press the **[OK]** key.

4 Set your original on the exposure glass (contact glass).

5 Press the **[Start]** key.

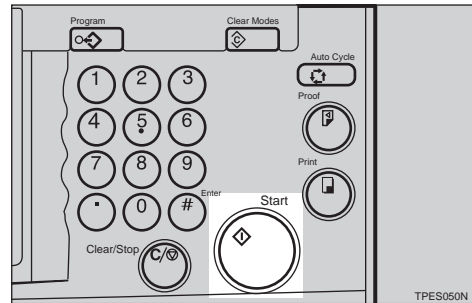

6 Check the image position of the trial or proof print.

Note

- If the image position is not correct, adjust it using the **[Image ⚙️]** key (see ⇒ P.25 “Adjusting Print Image Position”).

7 Make your prints.

Economy Mode—Saving Ink

1

When you want to save ink, select Economy mode.

Note

Prints will be lighter in this mode.

1 Press the **[Economy Mode]** key.

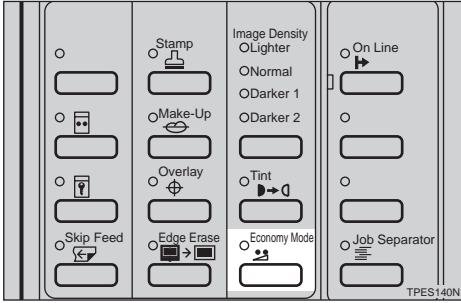

2 Set your original on the exposure glass (contact glass) or in the optional document feeder.

3 Press the **[Start]** key.

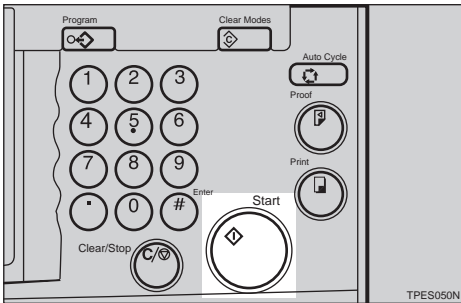

4 Check the image position of the trial or proof print.

Note

If the image position is not correct, adjust it using the **[Image ⌘]** key (see ⇒ P.25 “Adjusting Print Image Position”).

5 Make your prints.

Auto Cycle—Making Master And Prints At One Stroke

Use the **[Auto Cycle]** key to process masters and make prints at one stroke.

Note

- When you use the optional document feeder, it is not necessary to place originals one by one. All originals are fed and prints are completed after you press the **[Start]** key.

- 1** Set your original on the exposure glass (contact glass) or in the optional document feeder.

Note

- You can set up to 30 originals into the optional document feeder.

- 2** Enter the number of prints required with the Number keys.

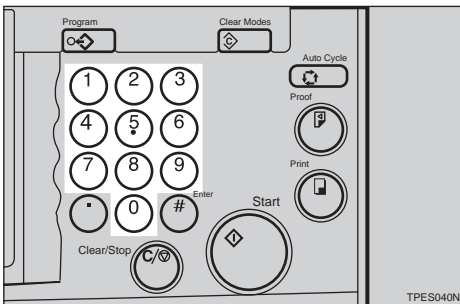

- 3** Press the **[Start]** key.

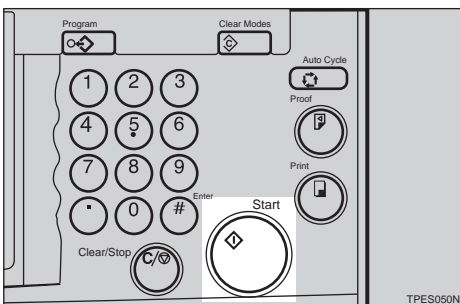

- 4** Check the image position of the trial or proof print.

Note

- If the image position is not correct, adjust it using the **[Image]** key (see ⇒ P.25 “Adjusting Print Image Position”).

- 5** Press the **[Auto Cycle]** key.

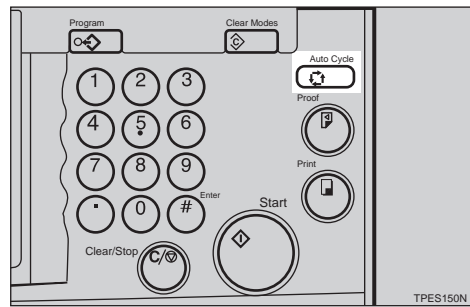

Note

- If you press the **[Auto Cycle]** key, you cannot make proof prints by pressing the **[Proof]** key.

- 6** Press the **[Print]** key.

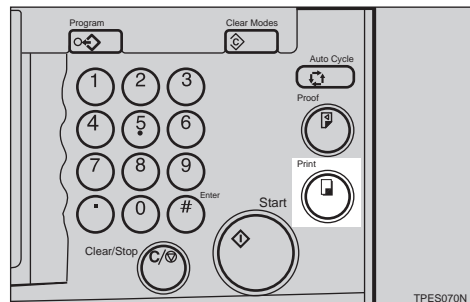

Note

- Repeat steps **1** through **3** until all originals are printed when you are setting originals on the exposure glass (contact glass).

- If you set original in the optional document feeder, originals are fed and prints are completed automatically.

All Class Mode—Making Variable Numbers Of Prints From The Same Original Using All Stored Data

1

Preparation

You have to store the number of students in each class with the user tools. See ⇒ P.149 “3-5 Class Enter No.”.

Use the **[Class]** key to make sets of prints from the same original. All the stored numbers of prints are made for each set.

This feature is useful for teachers who frequently make multiple print sets for all the classes. Ex. notes, handouts, test etc.

Using a standard print function, the teacher would have to stand by the machine entering the number of prints and pressing the **[Print]** key for each class. However, All Class mode allows you to store the number of students in each class into the machine memory beforehand with the user tools. Then, whenever you need to make print sets for all the classes, set your original, select **[All]** and press the **[Start]** key. Print sets will be made containing the correct number of prints for each class.

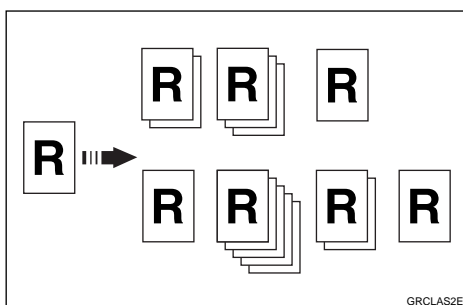

Note

- ❑ When you set All Class mode, Job Separation mode is automatically turned on. If you use Job Separation mode with this function, the job separator pulls the top sheet of the each set delivered to the paper delivery tray. This marks the end of each printing set. The next cycle begins automatically. See ⇒ P.77 “Job Separation—Separating Printing Sets On The Paper Delivery Tray”
- ❑ You can cancel Job Separation mode in All Class mode with the user tools (see “Auto Separate” in ⇒ P.139 “4. Mode Setting”).

1 Press the **[Class]** key.

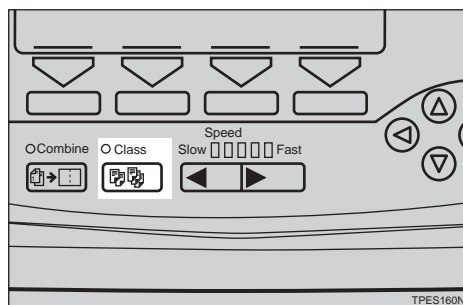

2 Make sure that the **[All]** is selected.

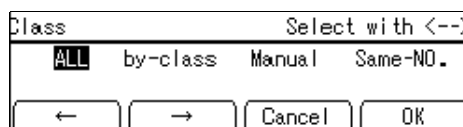

3 Press the **[OK]** key.

4 Set one original on the exposure glass (contact glass) or in the optional document feeder.

5 Press the **[Start]** key.

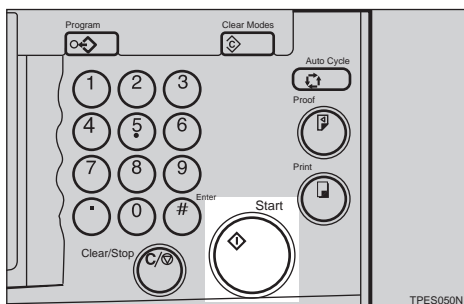

6 Check the image position of the trial or proof print.

Note

- If the image position is not correct, adjust it using the **[Image ⌘]** key (see ⇒ P.25 "Adjusting Print Image Position").

7 Make your prints.

Auto Class Mode— Making Variable Numbers Of Prints From The Same Original Using Stored Data

Preparation

You have to store the number of students in each class with the user tools. See ⇒ P.149 “3-5 Class Enter No.”.

Use the **[Class]** key to make sets of prints from the same original. The stored numbers of prints are made for each set.

This feature is useful for teachers who frequently make multiple print sets for their classes, ex. notes, handouts, tests etc.

Using a standard print function, the teacher would have to stand by the machine entering the number of prints and pressing the **[Print]** key for each class. However, Auto Class mode allows you to store the number of students in each class into the machine memory beforehand with the user tools. Then, whenever you need to make print sets for several classes, set your original, select the classes who need prints and press the **[Start]** key. Print sets will be made containing the correct number of prints for each class.

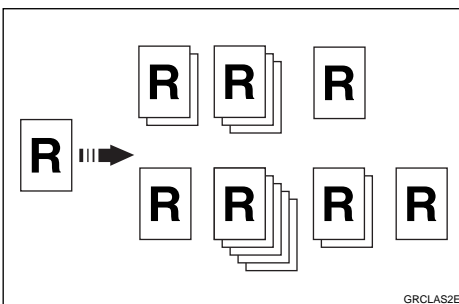

Note

- When you set Auto Class mode, Job Separation mode is automatically turned on. If you use Job Separation mode with this function, the job separator pulls the top sheet of the each set delivered to the paper delivery tray. This marks the end of each printing set. The next cycle begins automatically. See ⇒ P.77 “Job Separation—Separating Printing Sets On The Paper Delivery Tray”.
- You can cancel Job Separation mode in Auto Class mode with the user tools (see “Auto Separate” in ⇒ P.139 “4. Mode Setting”).

1 Press the **[Class]** key.

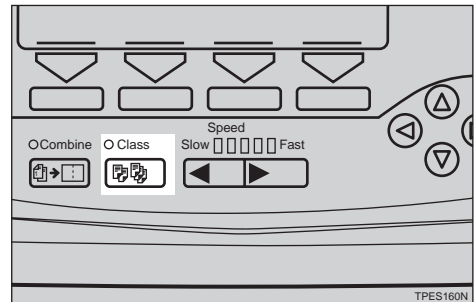

2 Select **[by-class]** with the **[→]** or **[▷]** key.

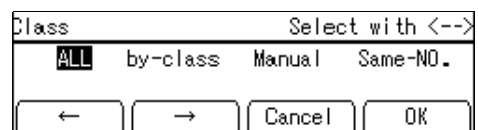

3 Press the [OK] key.

4 Select the desired classes for each grade.

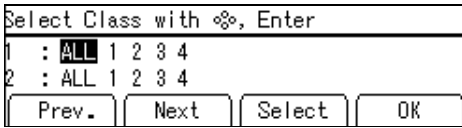

Selecting classes with the [\triangleleft], [\triangleright], [\triangle], or [∇] key

1 Select the desired class for the 1st grade with the [\triangleright] key.

You will find the number of students is displayed on the counter.

Note

- When you want to select all the classes, select [ALL].

2 Press the [Select] key.

Note

- Repeat steps **1** and **2** until you have finished designating classes for the 1st grade.
- When you want to cancel a class, select that class with the [\triangleleft], [\triangleright], [\triangle], or [∇] key and press the [Cancel] key.
- When you want to select many classes for one grade, first select [ALL] and press the [Select] key then deselect the unnecessary classes with the [Cancel] key.

3 Press the [∇] key.

Now, you can select classes for the 2nd grade.

4 Select the desired class for the 2nd grade with the [\triangleleft], [\triangleright], [\triangle], or [∇] key.

5 Press the [Select] key.

Note

- Repeat steps **3** to **5** until you have finished designating all the desired classes.

Selecting classes with the number keys

1 Enter the desired number of grade and class with the Number keys.

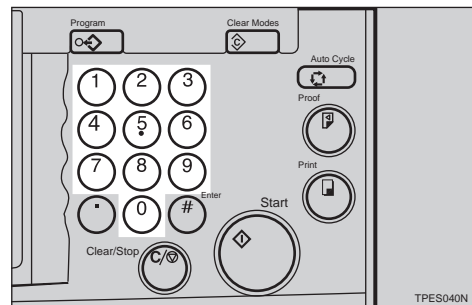

Note

- For example, to select grade 2 class 4, enter 24.
- When you want to select all the classes for one grade, enter the grade number followed by 0.

2 Press the [Enter] key.

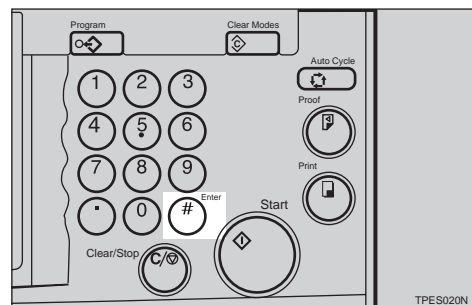

Note

- When you want to cancel a class, select that class with the [\triangleleft], [\triangleright], [\triangle], or [∇] key.

key and press the **[Cancel]** key.

- Repeat steps ❶ and ❷ until you have finished selecting all the desired classes.

5 Press the **[OK]** key.

6 Set one original on the exposure glass (contact glass) or in the optional document feeder.

7 Press the **[Start]** key.

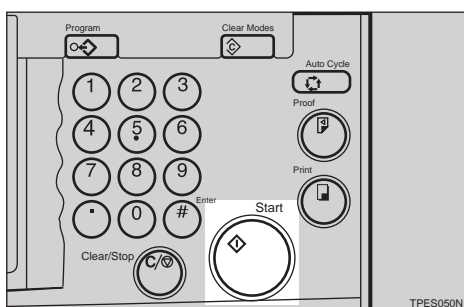

8 Check the image position of the trial or proof print.

Note

- If the image position is not correct, adjust it using the **[Image ⌘]** key (see ⇒ P.25 “Adjusting Print Image Position”).

9 Make your prints.

Manual Class Mode With One Original— Making Variable Numbers Of Prints From The Same Original

Use the **[Class]** key to make sets of prints from the same original. Various numbers of prints are made for each set.

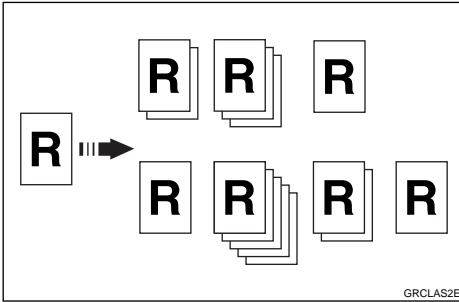

Note

- ❑ When you set Manual Class mode, Job Separation mode is automatically turned on. If you use Job Separation mode with this function, the job separator pulls the top sheet of the each set delivered to the paper delivery tray. This marks the end of each printing set. The next cycle begins automatically. See ⇒ P.77 “Job Separation—Separating Printing Sets On The Paper Delivery Tray”.
- ❑ You can cancel Job Separation mode in Manual Class mode with the user tools (see “Auto Separate” in ⇒ P.139 “4. Mode Setting”).

- 1 Press the **[Class]** key.

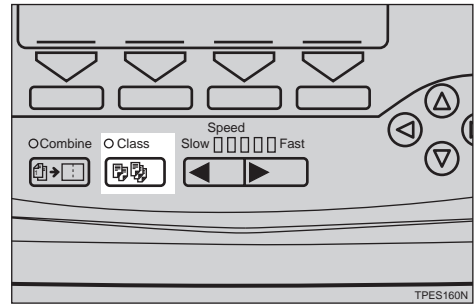

- 2 Select **[Manual]** with the **[→]** or **[▷]** key.

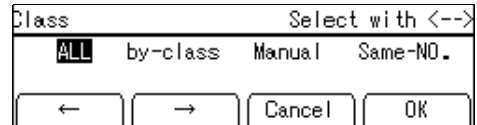

- 3 Press the **[OK]** key.

- 4 Enter the desired number of prints for the first set with the **Number** keys.

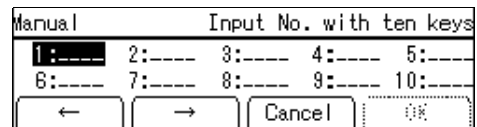

5 Press the **[Enter]** key.

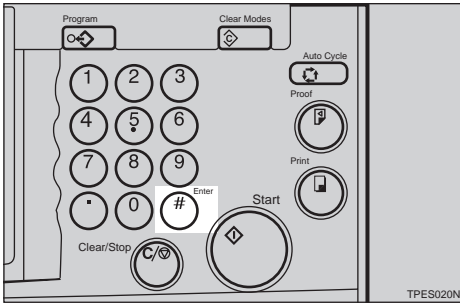

10 Press the **[Start]** key.

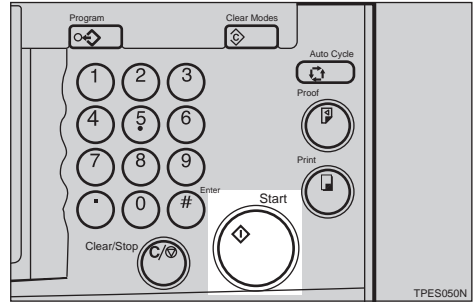

6 Enter the desired number of prints for the second set with the Number keys.

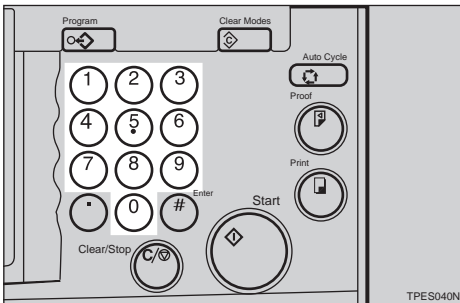

11 Check the image position of the trial or proof print.

Note

- If the image position is not correct, adjust it using the **[Image ⌘]** key (see ⇒ P.25 “Adjusting Print Image Position”).

12 Make your prints.

7 Press the **[Enter]** key.

Note

- Repeat steps **6** and **7** for each set.
- The maximum number of sets that can be made is 20.

8 Press the **[OK]** key.

9 Set one original on the exposure glass (contact glass) or in the optional document feeder.

Manual Class Mode With 2 Or More Originals—Making Variable Numbers Of Prints From Different Originals

Preparation

To use this function, you have to select “by each original” with the “Class Manual Set” user tool. See “Class Manual Set” in ⇒ P.139 “4. Mode Setting”.

Use the **[Class]** key to make sets of prints from the different originals. Various numbers of prints are made for each set.

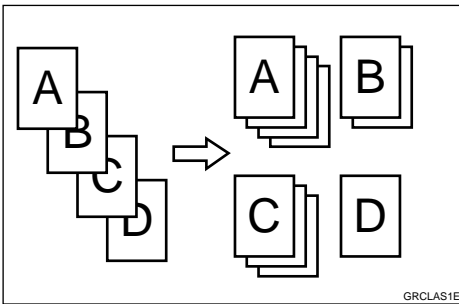

Note

- ❑ When you set Manual Class mode, Job Separation mode is automatically turned on. If you use Job Separation mode with this function, the job separator pulls the top sheet of the each set delivered to the paper delivery tray. This marks the end of each printing set. The next cycle begins automatically. See ⇒ P.77 “Job Separation—Separating Printing Sets On The Paper Delivery Tray”.
- ❑ You can cancel Job Separation mode in Manual Class mode with the user tools (see “Auto Separate” in ⇒ P.139 “4. Mode Setting”).
- ❑ With the optional document feeder, you can set several originals

and make prints of all of them at once. See ⇒ P.84 “Manual Class Mode With 2 Or More Originals Using The Document Feeder”.

1 Press the **[Class]** key.

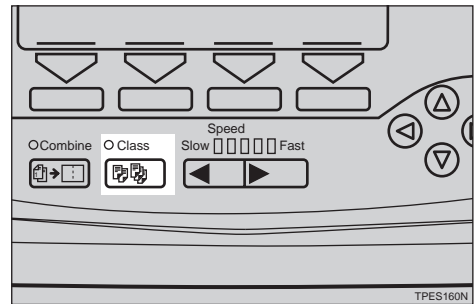

2 Select **[Manual]** with the **[→]** or **[▷]** key.

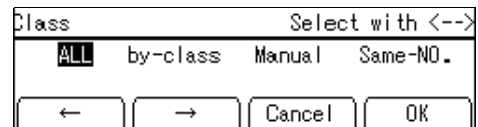

3 Press the **[OK]** key.

4 Enter the desired number of prints for the first original with the Number keys.

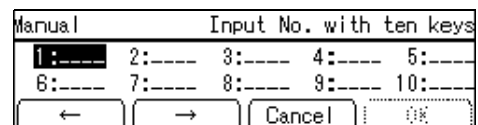

5 Press the **[Enter]** key.

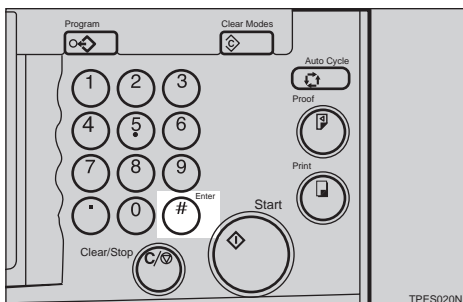

6 Enter the desired number of prints for the second original with the Number keys.

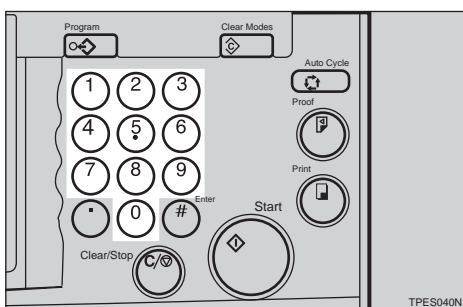

7 Press the **[Enter]** key.

Note

- Repeat steps **6** and **7** for each original.
- The number of prints for up to 20 originals can be stored.

8 Press the **[OK]** key.

9 Set the first original face down on the exposure glass (contact glass).

10 Press the **[Start]** key.

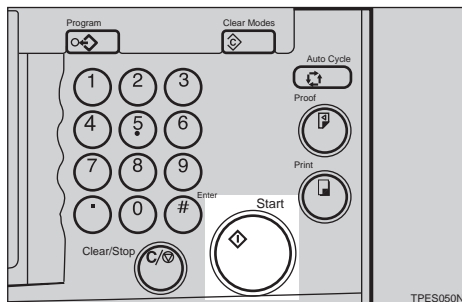

11 Check the image position of the trial or proof print.

Note

- If the image position is not correct, adjust it using the **[Image ⌘]** keys (see ⇒ P.25 “Adjusting Print Image Position”).

12 Press the **[Auto Cycle]** key.

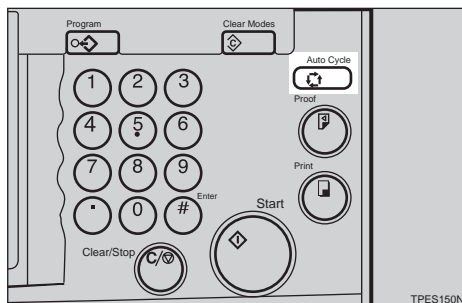

Note

- If you press the **[Auto Cycle]** key, you cannot make proof prints by pressing the **[Proof]** key.

13 Press the **[Print]** key.

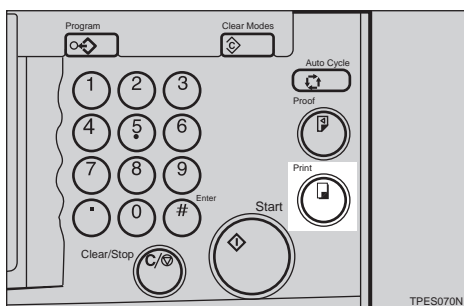

14 After the first set is completed, set the second original on the exposure glass (contact glass) and press the **[Start]** key.

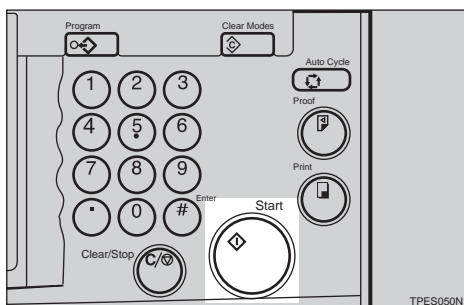

Note

- Repeat step **14** until you have finished printing.

Class Mode—Making Fixed Numbers Of Prints From The same Original

Use the **[Class]** key to make sets of prints from the same original. The same numbers of prints are made for each set.

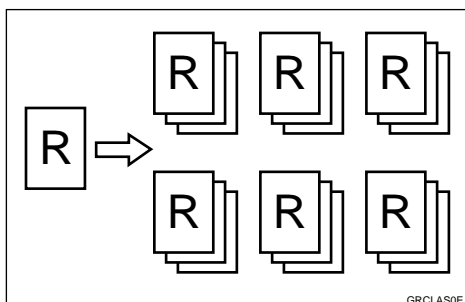

Note

- ❑ When you set Class mode, Job Separation mode is automatically turned on. If you use Job Separation mode with this function, the job separator pulls the top sheet of the each set delivered to the paper delivery tray. This marks the end of each printing set. The next cycle begins automatically. See ⇒ P.77 “Job Separation—Separating Printing Sets On The Paper Delivery Tray”.
- ❑ You can cancel Job Separation mode in Class mode with the user tools. See “Auto Separate” in ⇒ P.139 “4. Mode Setting”.

1 Press the **[Class]** key.

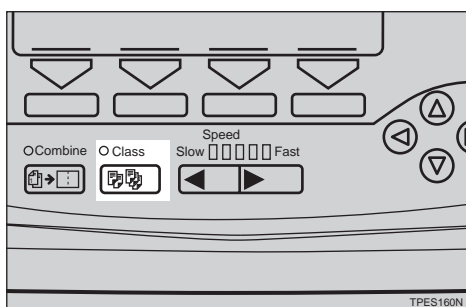

2 Select **[Same-NO.]** with the **[←]** or **[↵]** key.

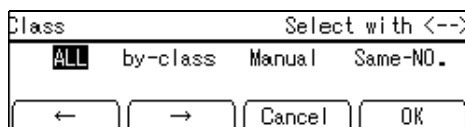

3 Press the **[OK]** key.

4 With the Number keys, enter the desired number of prints for each set.

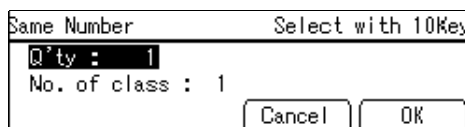

5 Press the **[Enter]** key.

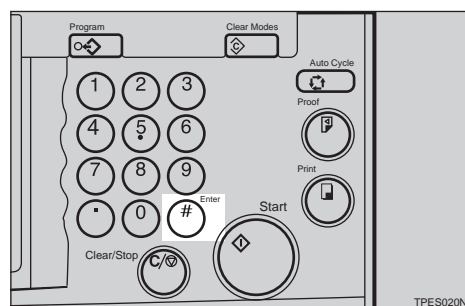

1

6 With the Number keys, enter the number of sets you wish to make.

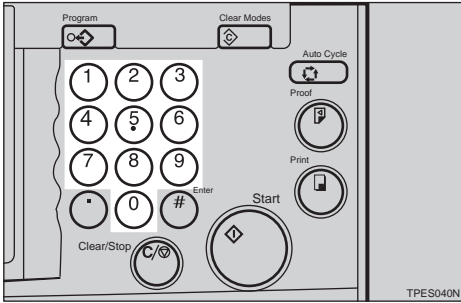

Note

- Up to 99 sets can be selected for an original.

7 Press the [OK] key.

8 Set one original on the exposure glass (contact glass) or in the optional document feeder.

9 Press the [Start] key.

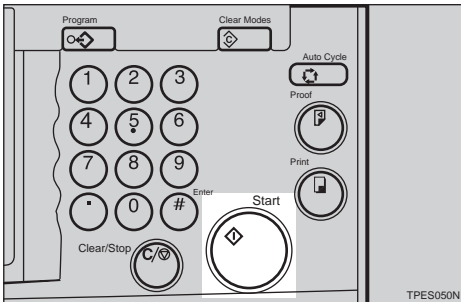

10 Check the image position is the trial or proof print.

Note

- If the image position is not correct, adjust it using the [Image ⌘] key. See ⇒ P.25 "Adjusting Print Image Position".

11 Make your prints.

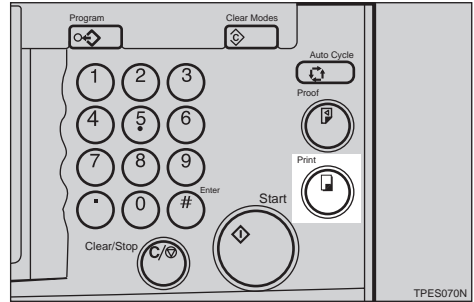

Combine Originals—Combining Originals Into One Print

You can combine originals in two ways:

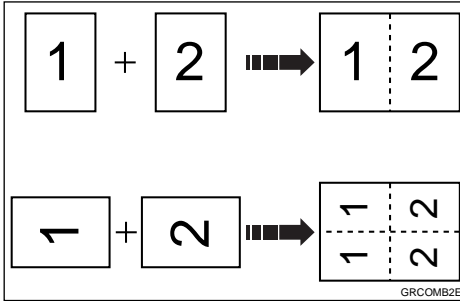

❖ 2 One-sided Originals → 1 One-sided Print Of 2 Images

Combine two single-sided originals onto one single-sided print with the two images placed side-by-side.

❖ 2 One-sided Originals → 1 One-sided Print Of 4 Images

Combine two single-sided originals onto one single-sided print with each image duplicated (total of four images).

Note

- If your machine has the optional memory board, you can also use Memory Combine mode. See ⇒ P.124 “Memory Combine—Combining Originals Into One Print With The Memory Board”.
- You can set the machine to cancel Combine Originals mode after finishing your print job with the user tools. See “Cancel Comb.” in ⇒ P.139 “4. Mode Setting”.
- Any image closer than 10 mm, 0.4" to the leading edge of the first original will not be printed. Also, any image closer than 4 mm, 0.16" to the leading edge of the second original will not be printed. When the image is too close to the leading edge, use copies of the originals with the image shifted at least 10 mm, 0.4" for the first original (4 mm, 0.16" for the second original) from the leading edge.
- You can select different kinds of image settings for the first and second original.
- Make sure that the paper feed side/end plates touch the paper lightly and the paper size and direction in the panel display correspond with the actual paper size and direction set on the paper feed tray. Otherwise, the two original images will not appear at the proper position on the prints.
- The following tables list the combinations that can be used in 2 one-sided originals → 1 one-sided print of 2 images mode:

❖ Metric version

		Original Size				
		A4	B5	A5	B6	A6
Paper Size	A3	100 %	115 %	141 %	163 %	200 %
	B4	87 %	100 %	122 %	141 %	173 %
	A4	71 %	82 %	100 %	115 %	141 %
	B5	61 %	71 %	87 %	100 %	122 %
	A5	50 %	58 %	71 %	82 %	100 %

❖ Inch version









		Original Size	
		8 1/2" × 11"	5 1/2" × 8 1/2"
Paper Size	11" × 17"	100 %	129 %
	8 1/2" × 14"	77 %	100 %
	8 1/2" × 11"	65 %	100 %
	5 1/2" × 8 1/2"	50 %	65 %

□ The following tables list the combinations that can be used in 2 one-sided originals → 1 one-sided print of 4 images mode:

❖ Metric version

		Original Size						
		A3	B4	A4	B5	A5	B6	A6
Paper Size	A3	50 %	58 %	71 %	82 %	100 %	115 %	141 %
	B4	-	50 %	61 %	71 %	87 %	100 %	122 %
	A4	-	-	50 %	58 %	71 %	82 %	100 %
	B5	-	-	-	50 %	61 %	71 %	87 %
	A5	-	-	-	-	50 %	58 %	71 %

◆ Inch version

		Original Size			
		11" × 17" 	8 ¹ / ₂ " × 14" 	8 ¹ / ₂ " × 11" 	5 ¹ / ₂ " × 8 ¹ / ₂ " 
Paper Size	11" × 17" 	50 %	65 %	65 %	100 %
	8 ¹ / ₂ " × 14" 	-	50 %	50 %	77 %
	8 ¹ / ₂ " × 11" 	-	-	50 %	77 %
	5 ¹ / ₂ " × 8 ¹ / ₂ " 	-	-	-	50 %

- If the proper reproduction ratio is not selected, images might not completely appear on prints.

Reference

When you use the optional document feeder with this function, see ⇒ P.83 "Combine Originals Printing With The Document Feeder".

1 Set the first original face down.

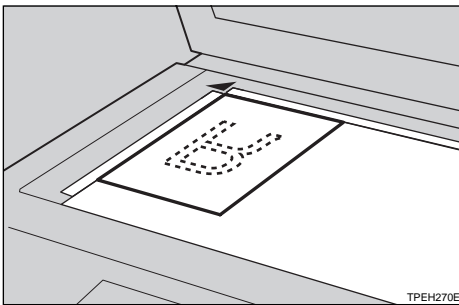

Note

- When you set original sideways () , the top should be toward the operation panel as shown above.

2 Enter the number of prints using the Number keys.

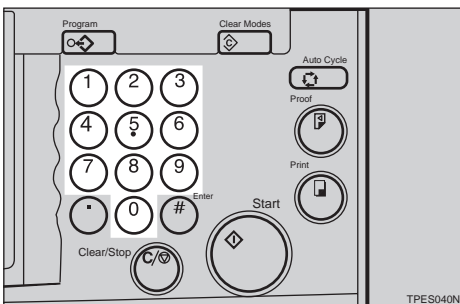

3 Check the print paper size and the reproduction ratio.

Note

- To have the machine choose a suitable ratio automatically, use Auto Magnification Selection mode. See ⇒ P.32 “Auto Magnification Selection—Having The Machine Choose The Reproduction Ratios”.

1

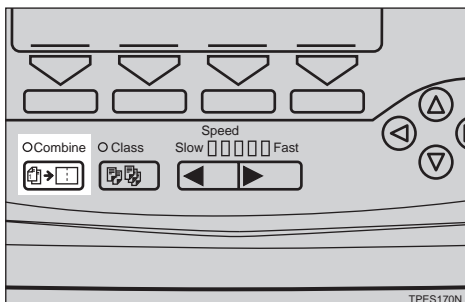
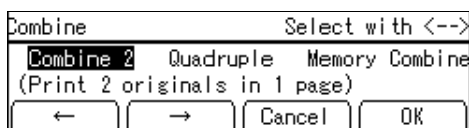
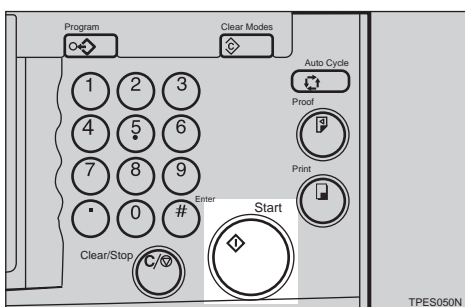
4 Press the **[Combine]** key.**5** Select **[combine 2]** or **[Quadruple]** with the **[←]**, **[→]**, **[◀]**, or **[▶]** key.**6** Press the **[OK]** key.**7** Press the **[Start]** key.

- 8 The beeper sounds after the first original has been stored. Set the second original face down.

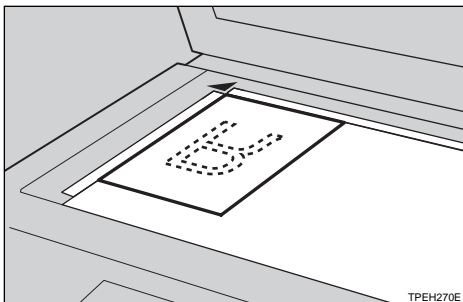

- 9 Press the **[Start]** key.

- 10 Check the image position of the trial or proof print.

 **Note**

- If the image position is not correct, adjust it using the **[Image ⌘]** key (see ⇒ P.25 “Adjusting Print Image Position”).

- 11 Make your prints.

Auto Combine Mode—Having Images Repeated On One Print

1

Preparation

To use this function, you have to select Auto Combine mode with the user tools. See “Combine” in ⇒ P.139 “4. Mode Setting”.

You can have images repeated in two ways:

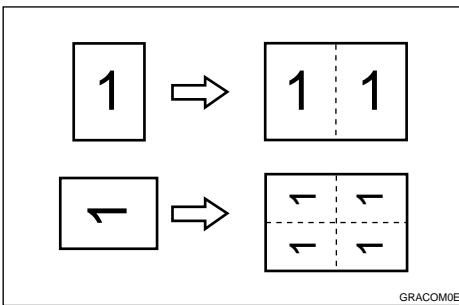

❖ 1 One-sided Originals → 1 One-sided Print Of 2 Images

The original image is duplicated twice on one print.

❖ 1 One-sided Originals → 1 One-sided Print Of 4 Images

The original image is duplicated four times on one print.

Reference

See ⇒ P.63 “Combine Originals—Combining Originals Into One Print” for details.

1 Set your original on the exposure glass (contact glass) or in the optional document feeder.

2 Enter the number of prints using the Number keys.

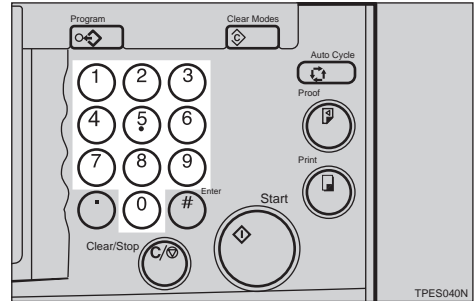

3 Check the print paper size and the reproduction ratio.

Note

- To have the machine choose a suitable ratio automatically, use Auto Magnification Selection mode. See ⇒ P.32 “Auto Magnification Selection—Having The Machine Choose The Reproduction Ratios”.

4 Press the [Combine] key.

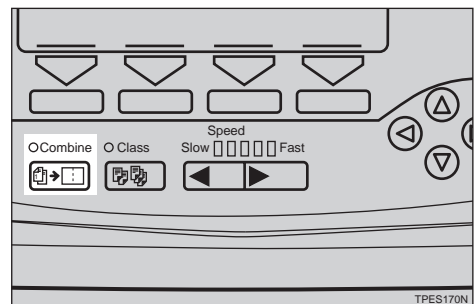

- 5** Select [Repeat 2] or [Repeat 4] with the [←], [→], [◀], or [▶] key.

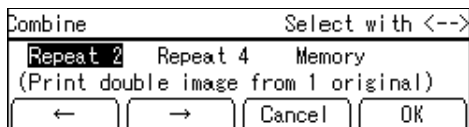

- 6** Press the [OK] key.

- 7** Press the [Start] key.

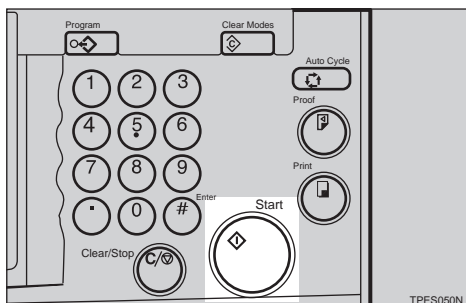

- 8** Check the image position of the trial or proof print.

Note

- If the image position is not correct, adjust it using the [Image ⌘] key. (see ⇒ P.25 “Adjusting Print Image Position”.)

- 9** Make your prints.

Skip Feed Printing

1

If the backs of prints are dirty, you can increase the time between two prints using the **[Skip Feed]** key. By default, when one sheet of paper is fed the drum rotates once. However, you can select the number of rotations of the drum. This gives you the chance to remove prints one by one from the paper delivery tray or insert one sheet of paper between two prints. If you use this function, you can also use paper longer than 432 mm, 17.0" in spite of the maximum length limitations of paper.

Note

- Two rotations while one sheet of paper is fed is selected as a default. You can change this default setting with the user tools. See "No. of Skip Feed" in ⇒ P.139 "4. Mode Setting".
- The maximum length of paper in Skip Feed mode is 460 mm, 18.1".
- When you use paper longer than 432 mm, 17.0", completed prints will not be delivered to the paper delivery tray properly, so lower the end plate and receive completed prints by hand.

1 Set your original on the exposure glass (contact glass) or in the optional document feeder.

2 Press the **[Skip Feed]** key.

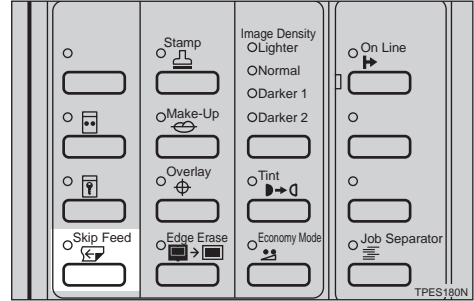

3 If necessary, select the number of rotations of the drum while one sheet of paper is fed with the **[←]**, **[→]**, **[◀]**, or **[▶]** key.

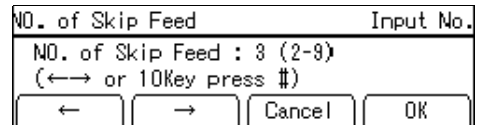

Note

- You can also select the number of rotations with the Number keys.
- You can select from 2 to 9 rotations.
- By default, the machine asks you to confirm the number of rotations. You can have this step omitted by adjusting the user tool settings. See "No. of Skip Feed" in ⇒ P.139 "4. Mode Setting".

4 Press the **[OK]** key.

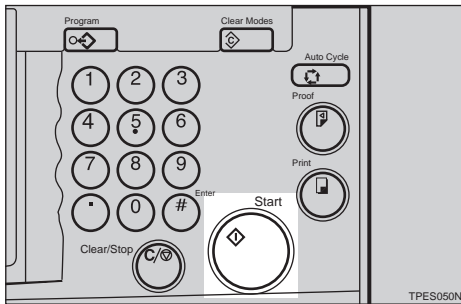
5 Press the **[Start]** key.**6** Check the image position of the trial or proof print.**Note**

- If the image position is not correct, adjust it using the **[Image ⌘]** key (see ⇒ P.25 "Adjusting Print Image Position").

7 Make your prints.**Note**

- After printing is completed, the Skip Feed setting returns to the default.

Program—Storing Your Print Settings In Memory

1

You can store up to 9 frequently used print job settings in machine memory and recall them for future use.

Note

- The stored programs are not cleared when you turn off the main switch.
- The stored programs cannot be deleted. If you want to change a stored program, overwrite it.

Storing Your Settings

- 1** Set the print settings you want to put into memory.
- 2** Press the **[Program]** key.

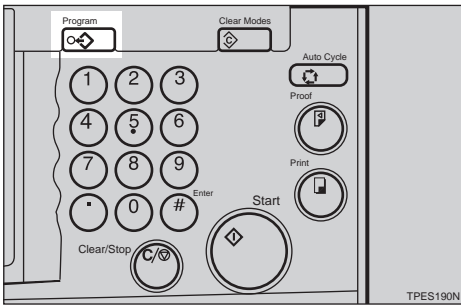

- 3** Select **[Store]** with the **[→]** or **[▷]** key.

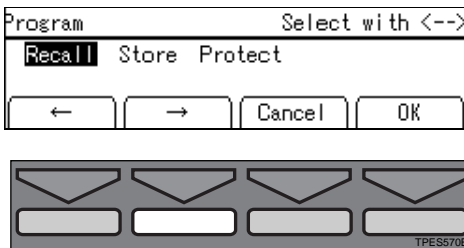

- 4** Press the **[OK]** key.

Note

- The program numbers (1 to 9) will be displayed in the panel display.
- If a user program has been protected, that program number will not appear in the display. To change a protected user program, see ⇒ P.73 "Protecting A Program".
- If all the user programs have been protected, you cannot store any settings. Press the **[Cancel]** key.

- 5** Select the program number you want to store the settings in with the **[←]**, **[→]**, **[◀]**, or **[▶]** key.

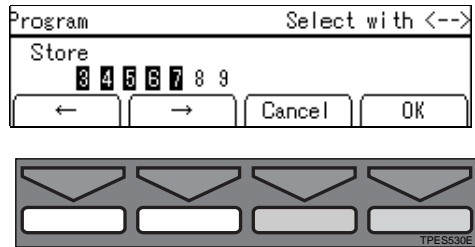

Note

- You can also select the program number with the Number keys.

- 6** Press the **[OK]** key.

Note

- If this program number is already used, the machine asks whether you wish to overwrite it or not. Press the **[Yes]** or **[No]** key.

Recalling A Program

1 Press the **[Program]** key.

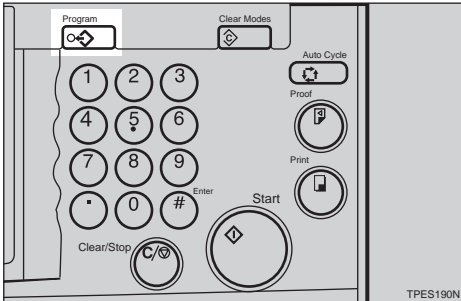

2 Make sure that **[Recall]** is selected.

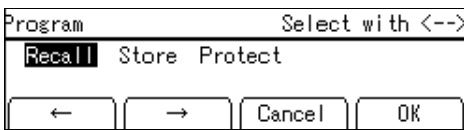

3 Press the **[OK]** key.

Note

- Programs that have been stored beforehand are represented by a number.

4 Select the program number you want to recall with the **[←]**, **[→]**, **[◀]**, or **[▶]** key.

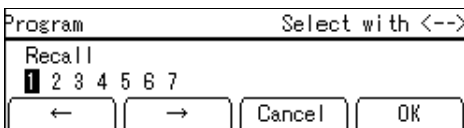

Note

- You can also select the program number with the Number keys.

5 Press the **[OK]** key.

6 Set your original on the exposure glass (contact glass) or in the optional document feeder.

7 Press the **[Start]** key.

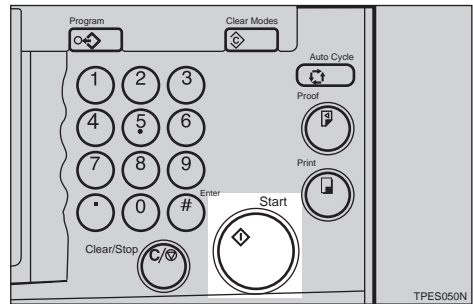

Protecting A Program

If you want to prevent someone from writing over your program, do the following procedure.

1 Press the **[Program]** key.

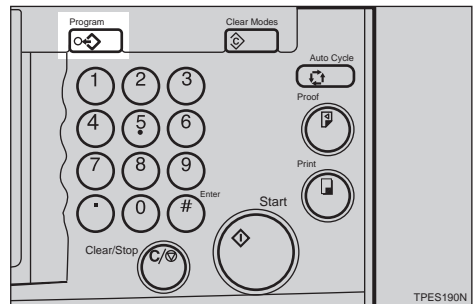

2 Select **[Protect]** with the **[←]** or **[◀]** key.

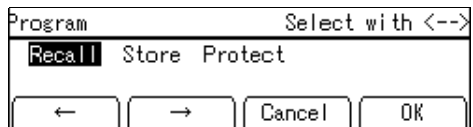

3 Press the **[OK]** key.

Note

- Already protected program numbers are shown with a black background (e.g. **1**).

1

- 4 Select the program number you want to protect with the [←], [→], [◀], or [▶] key.



Note

- You can also select the program number with the Number keys.

- 5 Press the [Select] key.

- 6 Press the [OK] key.

Removing Program Protection

- 1 Press the [Program] key.

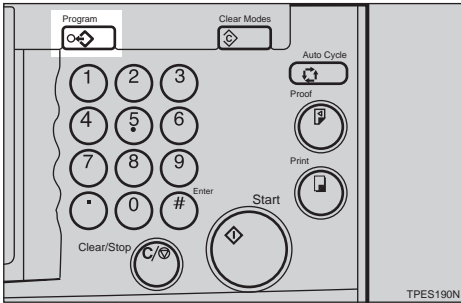

- 2 Select [Protect] with the [←] or [◀] key.

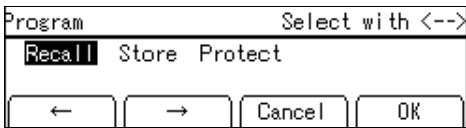

- 3 Press the [OK] key.

Note

- Already protected program numbers are shown with a black background (e.g. 1).

- 4 Select the program number you want to remove protection from with the [←], [→], [◀], or [▶] key.

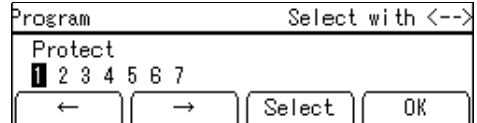

Note

- You can also select the program number with the Number keys.

- 5 Press the [Cancel] key.

- 6 Press the [OK] key.

Security Mode—Printing Secret Documents

This function prevents others from making prints of secret documents from the master. For example, if you want to print some documents with sensitive information, use this function after making your prints so that nobody can access that master again.

- You cannot pull out the drum unit before making the next master.

1 Make your prints.

2 Press the **[Security]** key.

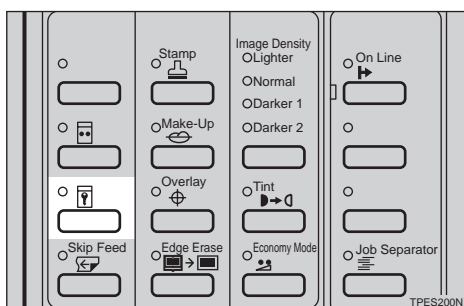

3 Press the **[Yes]** key.

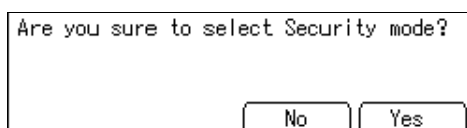

Note

- If you press the **[Proof]** key or the **[Print]** key after finishing one print job, the machine lets you know that you cannot make prints. Press the **[Exit]** key.
- You cannot cancel Security mode even if you turn off the main switch.
- If you make the next master, Security mode is canceled.

Quality Start Mode— Regaining The Image Density When The Ink On The Drum Dries

1

If the machine is not used for a long period of time or you change the color drum unit, the ink on the drum might dry causing print quality to deteriorate. To solve this problem, you can have the machine carry out a few idle spins of the drum before a print run. This will restore image quality and save you having to make a repeat print run.

You can use this feature in two ways:

❖ Manual Quality Start

Choose Quality Start for the next print run manually using the **[Quality Start]** key.

❖ Auto Quality Start

Have the machine check automatically how long ago the machine was used before each print run. If the machine has not been used for a long time, Quality Start will be used for the print job. By default, Auto Quality Start mode is on. You can turn it off with the user tools. See “Setting Q. start” in ⇒ P.139 “4. Mode Setting”.

📌 Note

- ❑ You can change the number of spins in Manual Quality Start mode with the user tools. See “Idling for Q.start” in ⇒ P.139 “4. Mode Setting”.
- ❑ You can change the number of spins after the fixed time period has passed in Auto Quality Start mode with the user tools. See “No. of Q.start” in ⇒ P.139 “4. Mode Setting”.

Using Quality Start Manually

1 Press the **[Quality Start]** key.

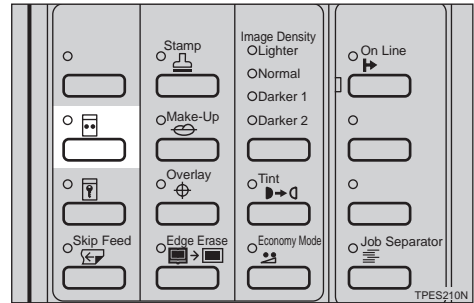

2 Set your original on the exposure glass (contact glass) or in the optional document feeder.

3 Press the **[Start]** key.

The drum unit idles.

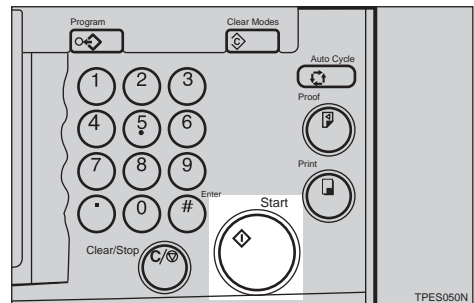

4 Make your prints.

Job Separation—Separating Printing Sets On The Paper Delivery Tray

The print on the top of each print set on the paper delivery tray is pulled by the job separator. This function is useful when you make 2 or more print sets.

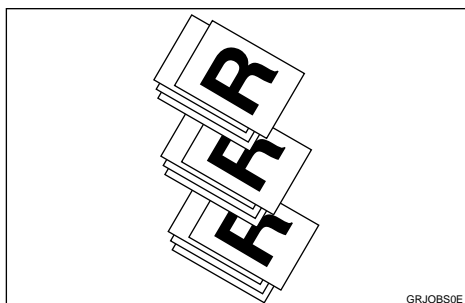

⚠ CAUTION:



- While printing, do not touch the belt at the end of the paper delivery tray or the job separator. You might be injured.

💡 Limitation

- In Job Separation mode, the following limitations apply:

❖ Metric version

Minimum paper size	Maximum paper weight	Paper delivery tray capacity
Length: 210 mm Width: 128 mm	127.9 g/m ²	600 sheets (64 g/m ²)

❖ Inch version

Minimum paper size	Maximum paper weight	Paper delivery tray capacity
Length: 8.3" Width: 5.1"	34 lb	600 sheets (17 lb)

📝 Note

- When you use thin paper, it is not recommended to use Job Separation mode. The job separator might tear the paper.
- If the job separator touches the print image, the completed prints might be dirty. In this case, it is not recommended to use Job Separation mode.
- When you do not use Job Separation mode, you can select the machine condition after each printing set is fed out to the paper delivery tray with the user tools. See “Manual Class” in ⇒ P.139 “4. Mode Setting”.

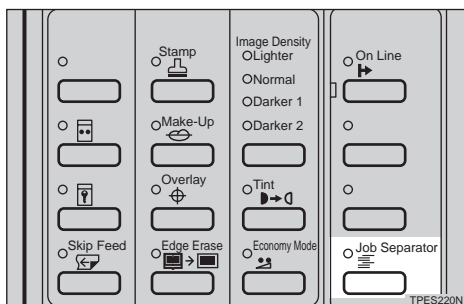
1 Press the **[Job Separator]** key.**2** Make your prints.**Note**

- After the last page of each printing set is fed out to the paper delivery tray, the job separator pulls the last sheet of each group in Job Separation mode. The next cycle begins.

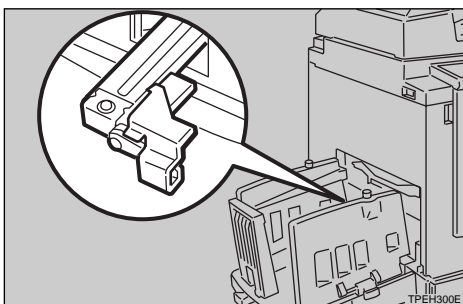

Saving Master

The machine automatically changes the master length depending on the paper size you use. This saves both master and ink.

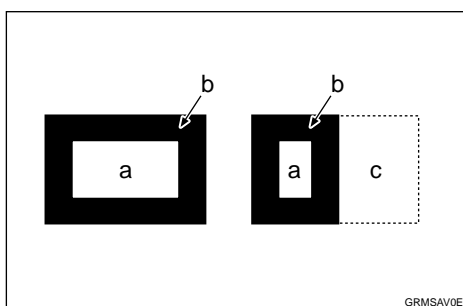

a = Images on the master

b = Masters

c = Area that you can save master and ink

! Limitation

- The optional document feeder is required.

📝 Note

- This function is turned on when you use A4, 8¹/₂" × 11" or B5 paper and you set 2 or more originals in the optional document feeder.
- You can cancel Master Saving mode with the user tools. See "Master Cut Length" in ⇒ P.139 "4. Mode Setting". You can also save master using the optional A4, 8¹/₂" × 11" drum. See ⇒ P.90 "Changing The Drum Size".

On Line Printing

1

The images on a personal computer can be printed using this machine.

Limitation

- ❑ The PC controller is required. For details, refer to the PC controller manual.

Note

- ❑ When you use A5, 5 1/2" x 8 1/2" , or paper of non-standard size, you need to select the paper size with the **[Ppr. Type]** key.
- ❑ When you use non-standard thickness or kind of paper, you need to select paper type with the **[Ppr. Type]** key before pressing the **[On Line]** key.

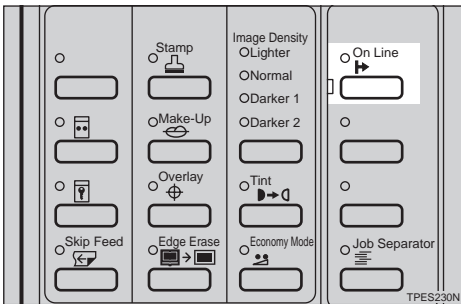

1 Press the **[On Line]** key.

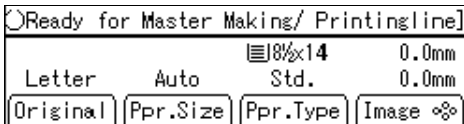

When you use A5, 5 1/2" x 8 1/2" , or non-standard paper sizes

1 Press the **[Ppr size]** key.



2 Select A5 , 5 1/2" x 8 1/2" , or Custom (non-standard) with the **[←]** or **[→]** key.

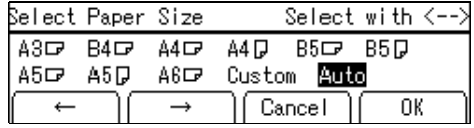

3 Press the **[OK]** key.

When you use paper sizes other than A5, 5 1/2" x 8 1/2" , or non-standard paper sizes

1 Refer to the PC controller manual.

2. OPTIONAL FUNCTIONS

Printing Using The Optional Document Feeder

Insert a stack of originals in the document feeder. It will be fed automatically.

Originals















Setting the following originals in the document feeder might cause original misfeeds or damage to the originals.

Set the following kinds of originals on the exposure glass (contact glass).

- Originals heavier than 105 g/m², 27 lb
- Originals lighter than 52 g/m², 14 lb
- Originals smaller than 105 mm × 128 mm, 4.2" × 5.1"
- Originals larger than 297 mm × 864 mm, 11.6" × 33.8"
- Stapled or clipped originals
- Perforated or torn originals
- Curled, folded, or creased originals
- Originals with any kind of coating, such as thermal fax paper, art paper, aluminum foil, carbon paper, or conductive paper
- Bound originals such as books
- Damaged originals
- Originals with glue on them
- Pasted originals
- Originals written in pencil

- Thin originals that have low stiffness
- Originals with index tabs
- Translucent paper

The following original sizes set in the document feeder can be detected.

Metric version	A3  , B4  , A4   , B5   , A5  
Inch version	11" × 17"  , 8 ¹ / ₂ " × 14"  , 8 ¹ / ₂ " × 11"   , 8 ¹ / ₂ " × 5 ¹ / ₂ "  

Under the following conditions, the machine might not detect the original. In this case, select the original image area with the **[Edge Erase]** key. See ⇒ P.40 "Edge Erase—Erasing Edge Margins".

- When you use originals with index tabs.
- When you use OHP transparencies or translucent paper.
- When you use dark originals.
- When you use originals with solid images.
- When you use originals other than the sizes described above.

Note

- Set originals after correction fluid and ink have completely dried. Not taking this precaution could mark the exposure glass (contact glass) and cause marks to be printed.

Basically, set originals as shown below.

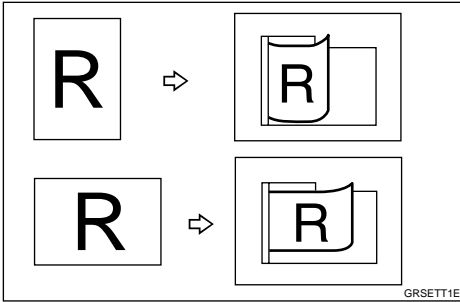

When you have an optional memory board and the original is set in a different direction from the print paper, the machine automatically rotates the original image by 90° to match the print paper direction.

You cannot set originals of different sizes at the same time.

When you use thin originals, set one original at a time in the document feeder or set them on the exposure glass (contact glass).

The first 10 mm, 0.4", of the leading edge and the last 2 mm, 0.08" of the trailing edge cannot be printed. Make sure the leading edge margin is at least 10 mm, 0.4", and the trailing edge margin is at least 2 mm, 0.08".

Do not stack originals above the limit mark.

Setting Originals In The Document Feeder

1 Adjust the guide to the original size.

2 Set the aligned originals face up into the document feeder.

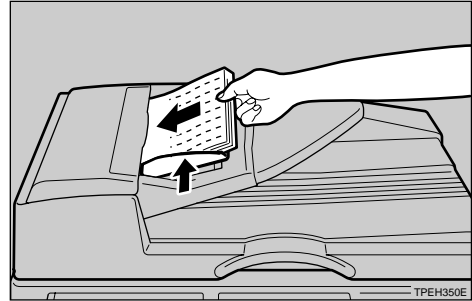

! Limitation

Approximately 30 originals (80 g/m², 21 lb) can be inserted at one time in the document feeder. The first (top) original will be fed first.

📎 Note

- To avoid a multi-sheet feed, shuffle the originals before setting them in the document feeder.
- The guides must fit snugly against both sides of the stack.

3 Adjust any print settings as necessary, then press the **[Start]** key.

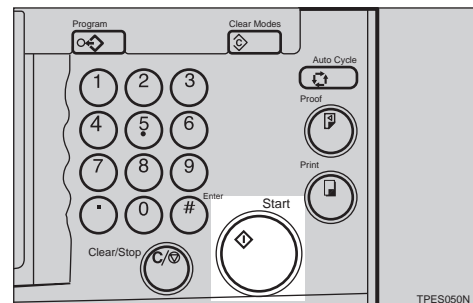

4 Make your prints.

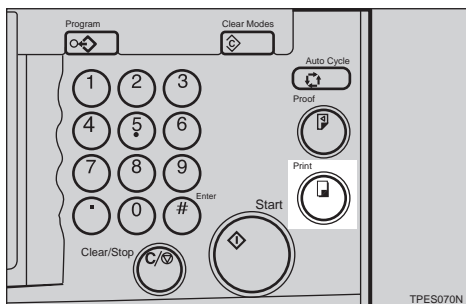

Note

- ❑ If the next original has been set in the document feeder before the machine stops, that original is fed automatically and a trial print is delivered to the paper delivery tray after the print of the first original is completed. Check the image position of the trial print of the next original. If necessary, make proof prints using the **[Proof]** key to check the image position again.

Combine Originals Printing With The Document Feeder

Reference

See ⇒ P.63 “Combine Originals—Combining Originals Into One Print” for details.

1 Insert the 2 originals face up.

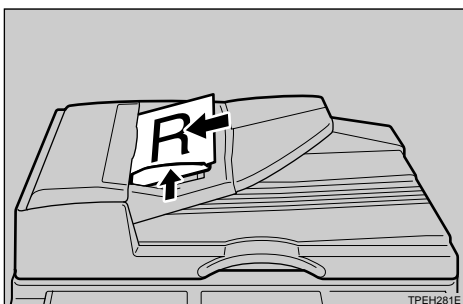

Note

- ❑ The top original will be printed on the leading part of print.

2 Enter the number of prints with the Number keys.

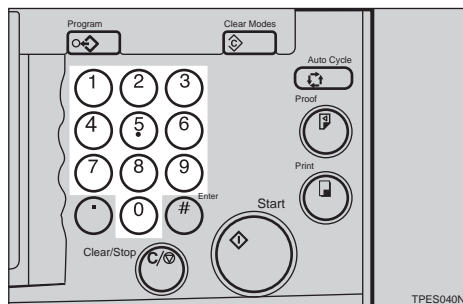

3 Check the print paper size and the reproduction ratio.

Note

- ❑ To have the machine choose a suitable ratio automatically, use Auto Magnification Selection mode. See ⇒ P.32 “Auto Magnification Selection—Having The Machine Choose The Reproduction Ratios”.

4 Press the [Combine] key.

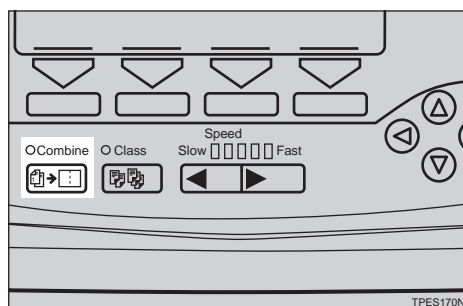

5 Select [Combine 2] or [Quadruple] with the [←], [→], [◀], or [▶] key.

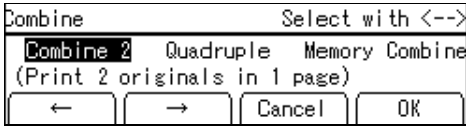

6 Press the [OK] key.

7 Press the [Start] key.

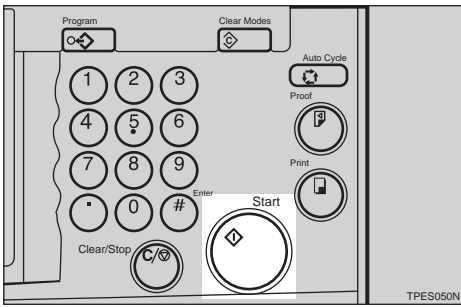

8 Check the image position of the trial or proof print.

Note

- If the image position is not correct, adjust it using the [Image ⌘] key (see ⇒ P.25 “Adjusting Print Image Position”).
- After the first original has been stored, the second original is fed.
- If you set only one original, the beeper sounds after the first original has been scanned in. Set the second original and the any print settings you require. Then, press the [Start] key.

Manual Class Mode With 2 Or More Originals Using The Document Feeder

Reference

See ⇒ P.58 “Manual Class Mode With 2 Or More Originals—Making Variable Numbers Of Prints From Different Originals”.

1 Press the [Class] key.

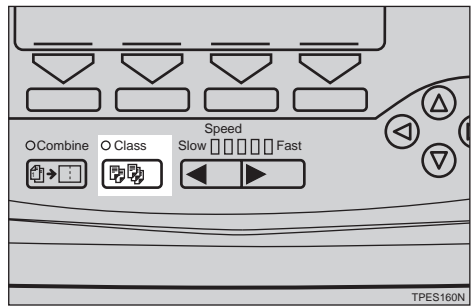

2 Select [Manual] with the [→] or [▶] key.

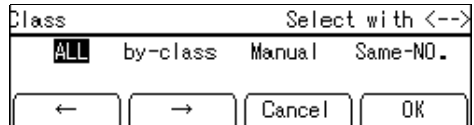

3 Press the [OK] key.

4 Enter the desired number of prints for the first original with the Number keys.

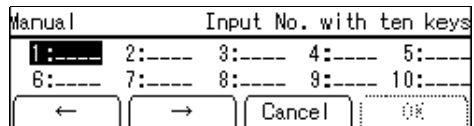

5 Press the **[Enter]** key.

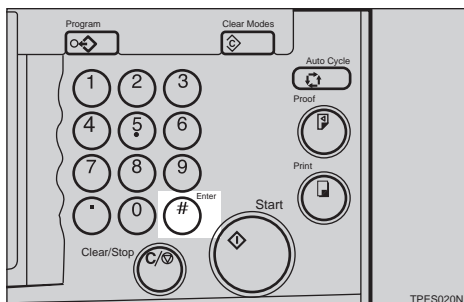

6 Enter the desired number of prints for the second original with the Number keys.

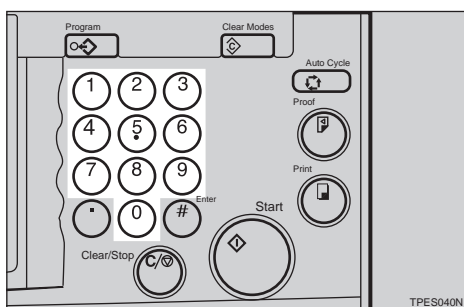

7 Press the **[Enter]** key.

Note

- Repeat steps **6** and **7** for each original.
- The number of prints for up to 20 originals can be stored.

8 Press the **[OK]** key.

9 Set your originals face up in the document feeder.

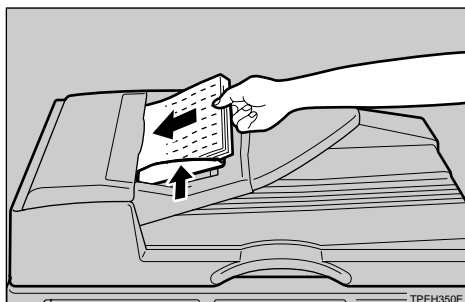

Note

- The originals are fed from the top of the stack. Make sure that the originals are set in the correct sequence with the first original on the top.

10 Press the **[Start]** key.

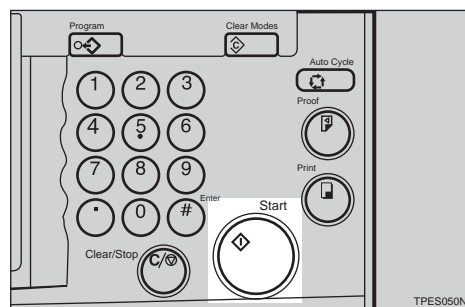

11 Check the image position of the trial or proof print.

Note

- If the image position is not correct, adjust it using the **[Image]** key (see ⇒ P.25 "Adjusting Print Image Position").

12 Press the **[Auto Cycle]** key.

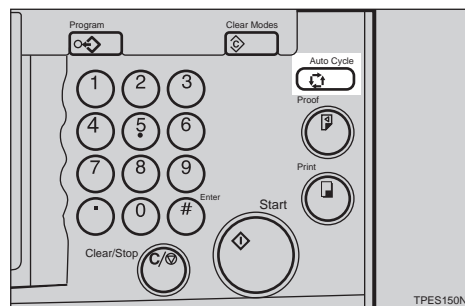

Note

- In Auto Cycle mode, printing starts automatically after a trial print is delivered.

2 Press the **[Print]** key.

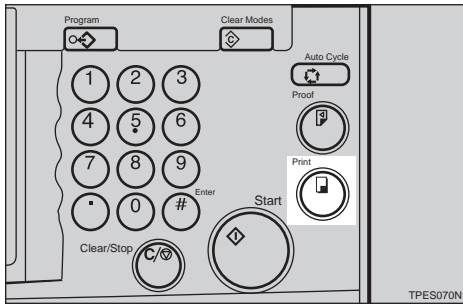

2

Color Printing Using The Optional Color Drum

Color drum units (red, blue, green, and brown) are available as options in addition to the standard black unit. For making color prints, a separate drum unit is necessary for each color.

Note

- ❑ If the ink on the color drum dries, use the Quality Start function. See ⇒ P.76 “Quality Start Mode— Regaining The Image Density When The Ink On The Drum Dries”.

Making Color Prints

- 1 Make sure that the Color Drum indicator is lit.

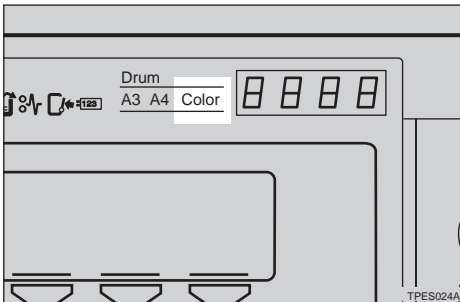

- 2 Press the **[Start]** key.
- 3 Check the image position of the trial or proof print.

Note

- ❑ If the image position is not correct, adjust it using the **[Image ⌘]** key (see ⇒ P.25 “Adjusting Print Image Position”).

- 4 Make your prints.

Changing The Color Drum Unit

- 1 Open the front door.

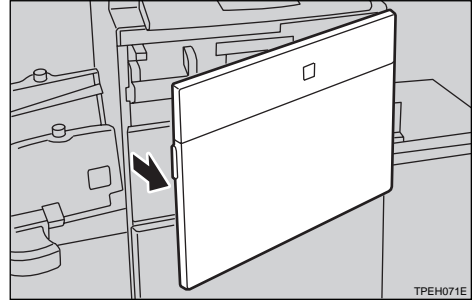

- 2 Lower lock lever B1.

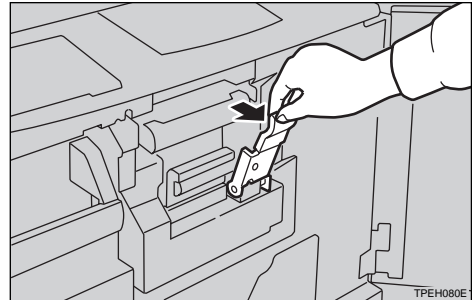

- 3 Pull out the drum unit handle B2 slowly.

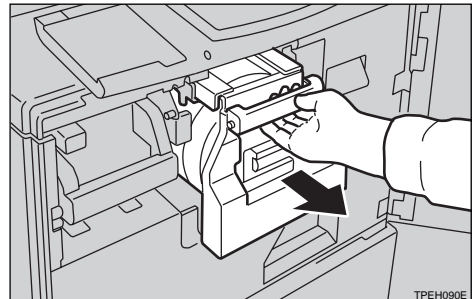

- 4 Lift upper drum stay B3 a little to unlock the drum unit, then pull

out the drum unit while holding handle B2 and drum stay B3.

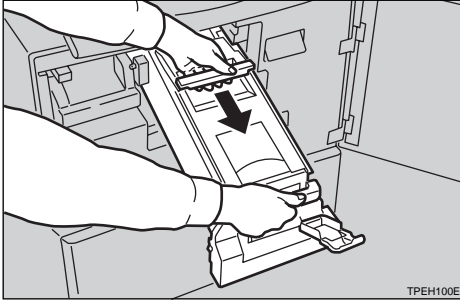

2

Important

- Be careful not to let the drum unit fall.

5 Lower lock lever B1 of the optional color drum.

6 Insert the color drum unit along the guide rail.

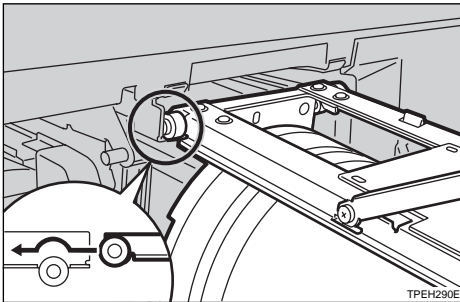

7 Slide in the drum unit until it locks in position.

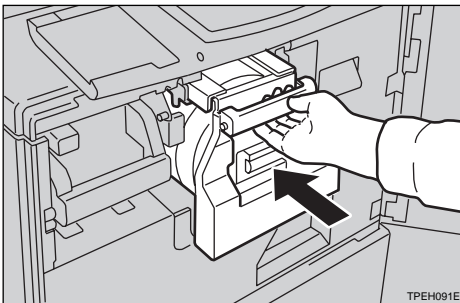

8 Lift the drum unit lock lever.

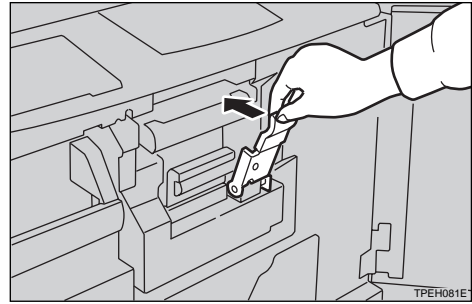

9 Close the front door.

Note

- Make sure that the **Open Cover/Unit** indicator turns off, and the **Color Drum** indicator lights.

Printing In Two Colors

After printing in one color, you can print in another color on the same side of the print.

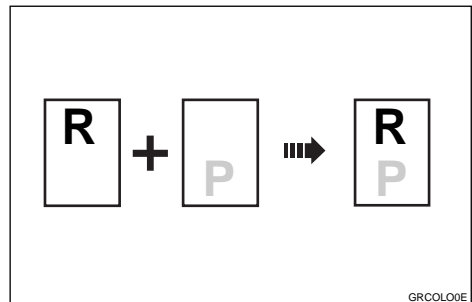

Note

- Leave the prints for a while before printing on them again to let the ink dry.
- If the prints are not dry, the paper feed roller might become dirty. In this case, wipe off the roller with a cloth.
- You cannot print in two colors at one time.

- 1** Prepare the two originals. Set the first original on the exposure glass (contact glass).

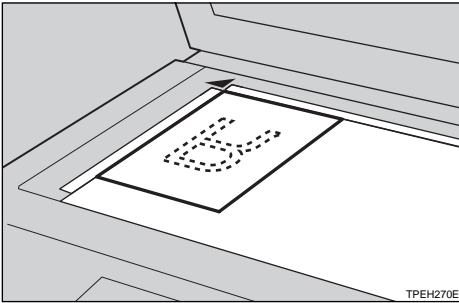

- 2** Enter the number of prints with the Number keys.

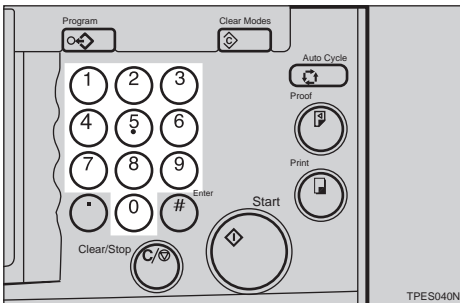

- 3** Press the **[Start]** key.

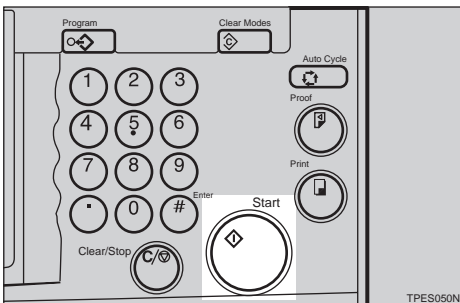

- 4** Check the image position of the trial or proof print.

 **Note**

- If the image position is not correct, adjust it using the **[Image ⌘]** key (see ⇒ P.25 "Adjusting Print Image Position").

- 5** Press the **[Print]** key.

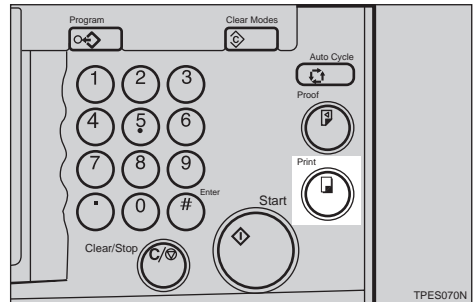

- 6** Remove the prints from the paper delivery tray and set them on the paper feed tray again as shown in the illustration.

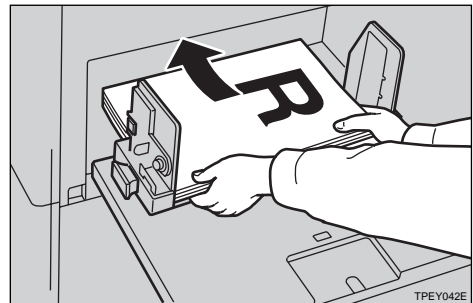

- 7** Exchange the drum unit. See ⇒ P.87 "Changing The Color Drum Unit".

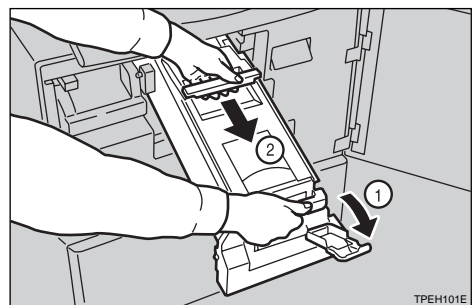

- 8** Set the second original and press the **[Start]** key.

- 9** Check the image position.

- 10** Press the **[Print]** key.

Changing The Drum Size

To save costs on master rolls and ink, you can shorten the length of each master by changing to an optional smaller drum.

2

Printing Area (at 23°C/73°F, 65 % RH)

❖ Metric version

A3 drum	More then 290 × 419 mm, 11.4" × 16.4"
A4 drum	More than 290 × 200 mm

❖ Inch version

11" × 17" drum	More then 290 × 409 mm, 11.4" × 16.1"
8 ¹ / ₂ " × 11" drum	More than 11.4" × 7.8"

Master Cut Length

A3 drum...320 mm × 530 mm, 12.5" × 20.9", 200 masters/roll

11" × 17" drum...320 × 540 mm, 12.5" × 21.3", 200 masters/roll

Optional A4 8¹/₂" × 11" drum...320 mm × 325 mm, 12.5" × 12.8", 330 masters/roll

Note

- To change the drum unit, follow the same procedure as ⇒ P.87 "Changing The Color Drum Unit".

Image Rotation—Rotating Original Images

When the direction in which your original is set is different from that of the paper, and your machine is equipped with the optional memory board, the machine automatically rotates the original image by 90° to match the paper direction.

Note

The following tables list the combinations that can be used in Image Rotation mode.









❖ Metric version

Original \ Paper	A3 	B4 	A4 	A4 	B5 	B5 	A5  ☆
A4 	--	--	--	★	--	★	★
A4 	★	★	★	--	★	--	--
B5 	--	--	--	★	--	★	★
B5 	★	★	★	--	★	--	--
A5 	--	--	--	★	--	★	★
B6 	--	--	--	★	--	★	★

★: The machine automatically rotates the original image by 90° to match the paper direction.

☆: Set this original in the optional document feeder.

❖ Inch version

Original \ Paper	11" × 17" 	8 1/2" × 14" 	8 1/2" × 11" 	8 1/2" × 11" 	8 1/2" × 5 1/2"  ☆	8 1/2" × 5 1/2"  ☆
8 1/2" × 11" 	--	--	--	★	--	★
8 1/2" × 11" 	★	★	★	--	★	--
8 1/2" × 5 1/2" 	--	--	--	★	--	★

★: The machine automatically rotates the original image by 90° to match the paper direction.

☆: Set these originals in the optional document feeder.

Note

When you select Zoom mode or you select non-standard size originals or paper, the image will not be rotated.

- ❑ It takes longer than usual to make masters in Image Rotation mode.
- ❑ You can cancel Image Rotation mode with the user tools. See “Auto Rotation” in ⇒ P.139 “4. Mode Setting”.

Make-up Printing Features

Make-up mode enables you to do more than just make an exact copy of the original. A variety of editing and image processing functions allow you to quickly and easily customize your prints.

Limitation









- The memory board option is required for this feature.

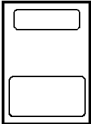

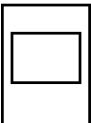

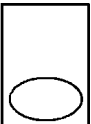

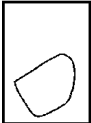
2

Main Features

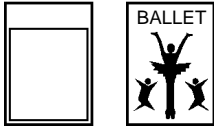

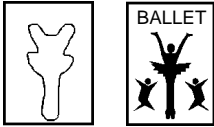
The use of command sheets allows you to create special effects without cutting and pasting - up to 4 commands can be given for an original. By combining Make-up functions with color drums, you can create a variety of printing effects.

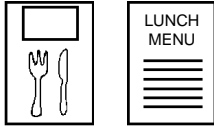
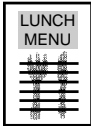
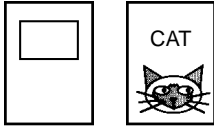

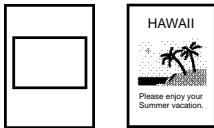

Make-up Modes For Designated Areas

Mode		Sample	
Designated Area		Command sheet/Original (Closed area method)	Print
1.	Letter mode	 	
2.	Photo mode	 	
3.	Delete Area mode	 	
4.	Outline mode	 	

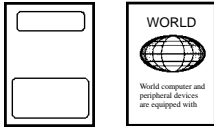
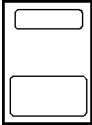
Mode		Sample	
Designated Area		Command sheet/Original (Closed area method)	Print
5.	P./N. mode (Positive Negative mode)		
6.	Solid mode (Image Pattern mode)		
7.	All Page Pattern mode (Area Pattern mode)		
8.	All + Outline (Image Outline and Area Pattern mode)		

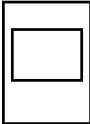
Make-up Modes For Outside Designated Areas

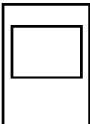
Mode		Sample	
Undesignated Area		Command sheet/Original	Print
1.	Letter mode: The area outside designated areas is printed in Letter mode.		
2.	Photo mode: The area outside designated areas is printed in Photo mode.		

Mode		Sample	
Undesignated Area		Command sheet/Original	Print
3.	Save Area mode: The area outside the designated areas is deleted.	 	
4.	Outline mode: The area outside the designated area is printed in Outline mode.	 	

 **Note**

- In Make-up mode, commands must be given for both designated areas and outside the designated area.

Background Patterns

There is a total of 164 background patterns for Make-up mode:

- 40 basic patterns
- 40 patterns similar to the basic patterns but with patterns elements at 4 times the size.
- 90° rotations of all the basic and enlarged patterns.
- 4 registered user patterns.

2

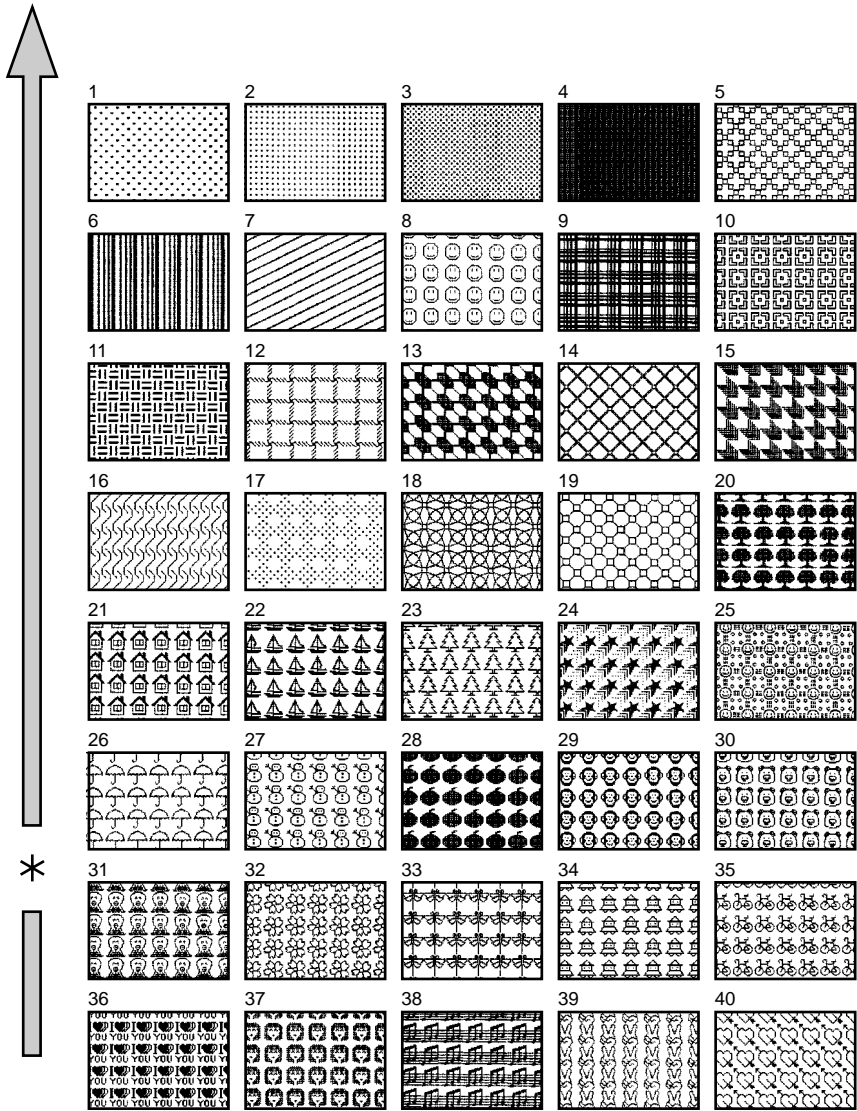

*= Paper Feed Direction

 **Note**

- The basic patterns are numbered 1 to 40.
- You can make your own make-up background patterns with the user tools.
See ⇒ P.161 *"5-15 Make/Chg. Pattern"*.

Making A Command Sheet For Make-Up Printing

Command sheets are fed first so that the machine can recognize the areas of the original which are to be edited as designated areas.

through the paper and get the exposure glass (contact glass) dirty.

2

Command sheet

The command sheet is a sheet of paper for designating areas to be edited. Command sheets must be made on white or translucent paper, and should be the same size as the original.

You can designate areas within the following limits:

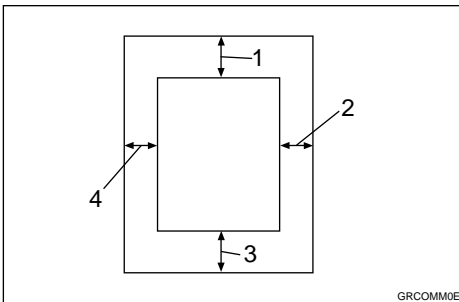

1. 5 mm, 0.2"

2. 0 mm, 0"

3. 0 mm, 0"

4. 0 mm, 0"

Note

- Poor quality paper (such as newsprint, recycled paper, etc.) should not be used for command sheets because any dark spots or streaks will be read as designated areas.
- Do not use blotting paper or other absorbent paper for command sheets because ink might leak

How To Make A Command Sheet

There are two ways of designating areas: the diagonal line method and the closed area method.

Features

- You can combine up to 4 command sheets when making a master.

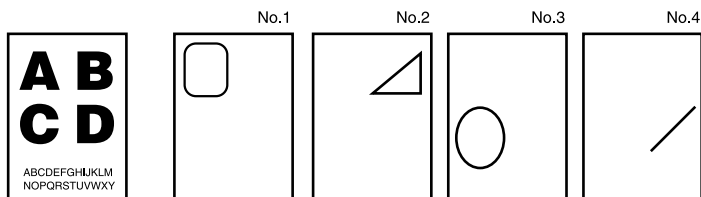

- You cannot use both the closed and diagonal line method on the same command sheet.

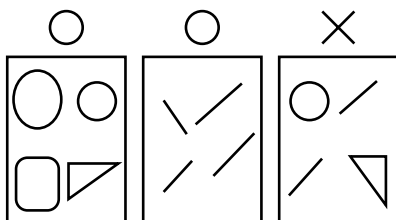

- You can designate many areas on one sheet and there is no limit to the number of areas you can designate.

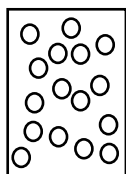

- If designated areas on two or more command sheets overlap, the last command sheet will apply for the overlapping portion.

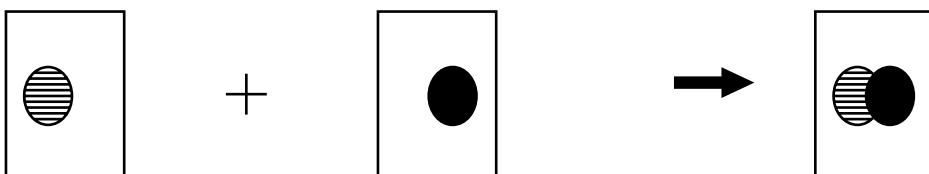





- If you use Outline mode for letter images with a thickness of less than 3 mm, 0.12", you might not get the proper print image.

Notes about drawing a command sheet

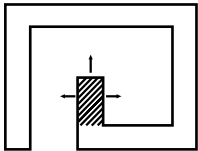
The image might differ depending on how the designated area is drawn, so remember the following when making the command sheet:

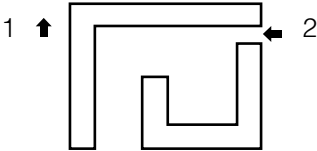
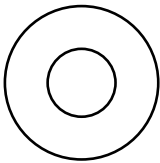
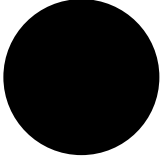
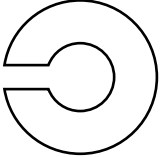
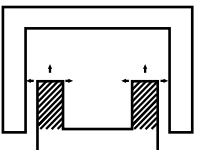
2

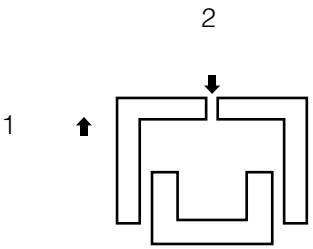
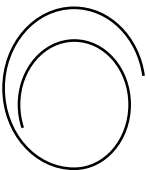
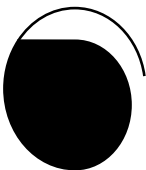
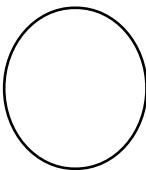
Designated area	Area recognized	Preferred designated area
<p>Part of the designated area is surrounded by 3 sides of the entire area.</p> 		<p>Make a space of at least 2 mm, 0.08", in front of the area surrounded by 3 sides (relative to the feed direction).</p>  <p>1, 2 = 2 mm, 0.08"</p>
<p>Double line pattern.</p> 	<p>Only the outer line is recognized.</p> 	<p>Make a gap of at least 2 mm, 0.08" in width.</p> 
<p>The designated area is surrounded by 3 sides of another designated area.</p> 		<p>Make a space of at least 2 mm, 0.08" in front of the area surrounded by 3 sides (relative to the feeding direction).</p>  <p>1, 2 = 2 mm, 0.08"</p>
<p>Non-closed line</p> 		<p>Designate the area with a closed line.</p> 

When using the diagonal line method

Note

- A diagonal line must be drawn through the area that you wish to edit.

1 Put the command sheet on top of the original.

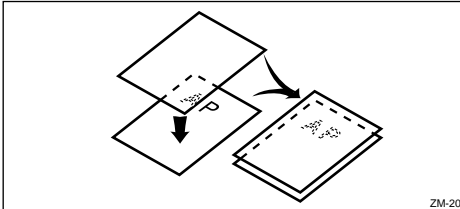

2 Draw a line using a felt tip pen (black, red or blue) with a thickness of at least 1 mm.

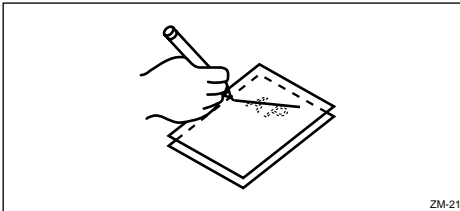

Note

- Make sure there is no break in the line.
- The diagonal line can be drawn from left to right or vice versa.
- Draw the line at least 2 mm, 0.08", away from the image so that the complete image can be recognized.

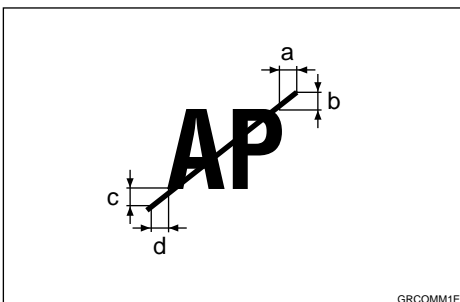

$a, b, c, d = 2 \text{ mm}, 0.08''$

- The line marking the designated area should be more than 2 mm, 0.08", from any neighboring image.

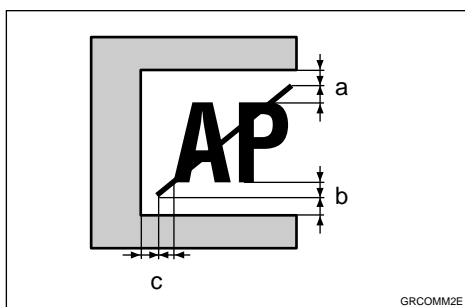

$a, b, c = 2 \text{ mm}, 0.08''$

When using the closed area method

 **Note**

- The line designating the area must be a closed loop.

1 Put the command sheet on top of the original.

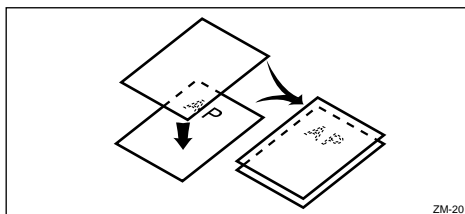

2 Using a black, red, or blue felt tip pen, draw a line around the area to designate. The line should have a thickness of at least 1 mm.

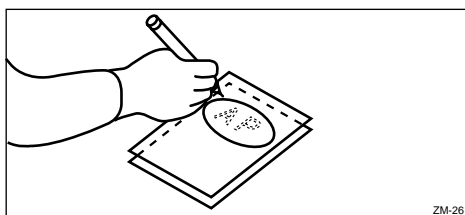

 **Note**

- Make sure there is no break in the line.
- Draw the line at least 2 mm, 0.08", away from the image so that the complete image can be recognized.

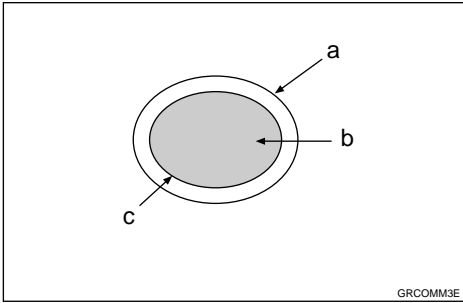

a = Line marking the designated area

b = 2 mm, 0.08"

c = Image within the designated area

☐ The line marking the designated area should be more than 2 mm, 0.08", from any neighboring image.

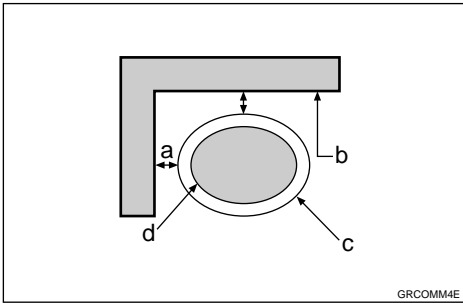

a = 2 mm, 0.08"

b = Neighboring image

c = Line marking the designated area

d = image within the designated area

Command Sheets And Finished Prints

The following illustrations will help you understand how to draw a command sheet.

❖ When drawing a command sheet using a diagonal line

2

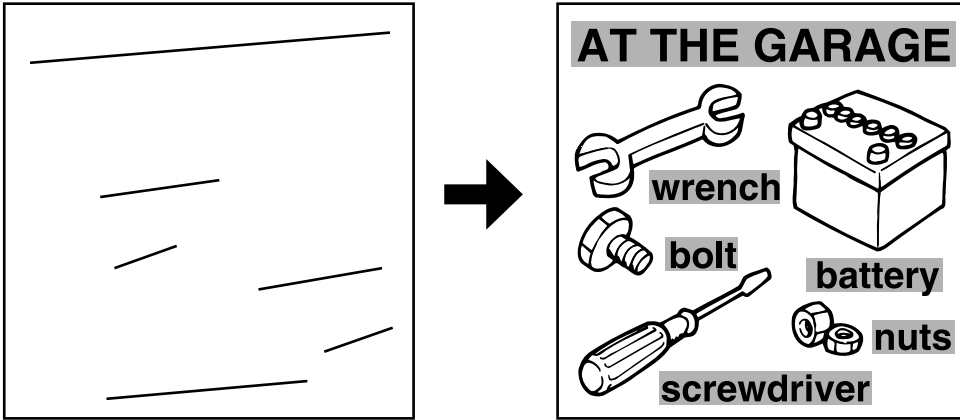

The diagonal line method is easy to use for designating rectangular areas. It is also more precise, but it is difficult to use for designating complex areas.

❖ When drawing a command sheet using a closed line

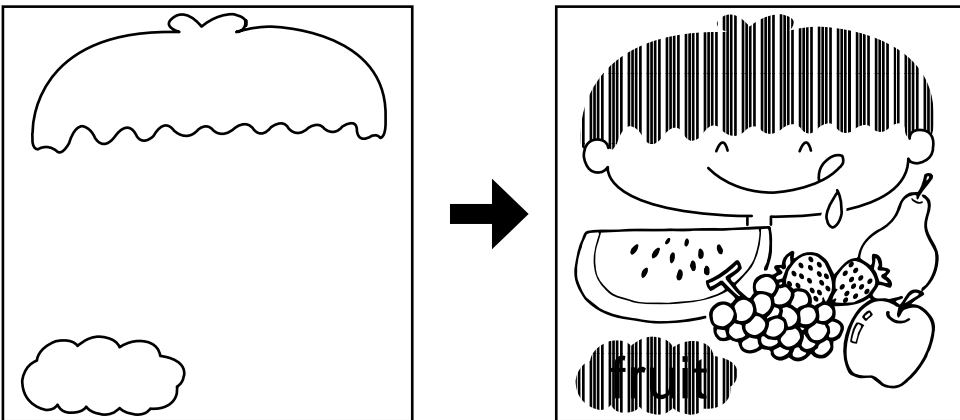

The closed line method is easier to use for complex areas, but it is less precise. It also takes longer to draw a command sheet with the closed line method.

Make-up Printing

1 Press the **[Make-Up]** key.

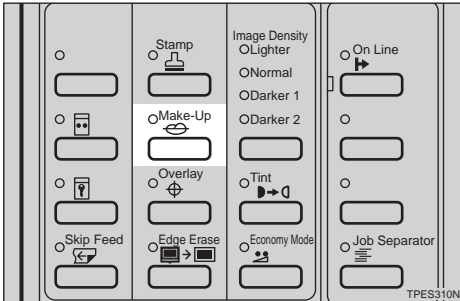

2 Make sure that **[1]** is selected. Then press the **[OK]** key.

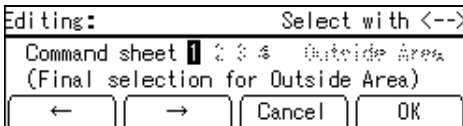

3 Select the frame shape with the **[←]**, **[→]**, **[◀]**, or **[▶]** key.

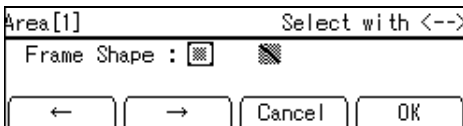

4 Press the **[OK]** key.

5 Select the mode for the first command sheet with the **[←]**, **[→]**, **[◀]**, **[▶]**, **[△]**, or **[▽]** key.

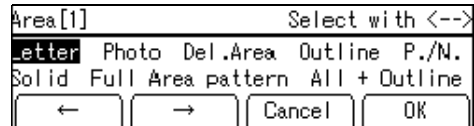

6 Press the **[OK]** key.

7 If necessary, select the pattern for the first command sheet with the **[◀]**, **[▶]**, **[△]**, or **[▽]** key. Then press the **[OK]** key.

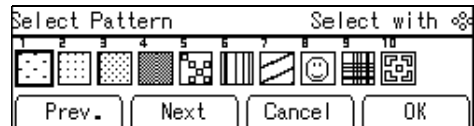

8 If necessary, select the size and direction of the pattern you selected in step **7** with the **[←]**, **[→]**, **[◀]**, or **[▶]** key.

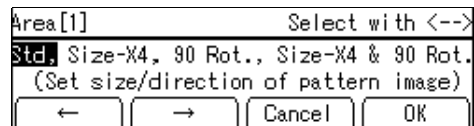

9 Press the **[OK]** key.

Note

- Follow steps **2** – **9** for the other command sheets.
- You can select a pattern registered with the user tools for only one command sheet.

- To change the value entered, press the **[Clear/Stop]** key and enter the new value.

10 After you have finished designating modes for all the command sheets, select **[Outside Area]** with the **[←]**, **[→]**, **[◀]**, or **[▶]** key. Then press the **[OK]** key.

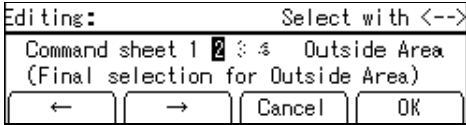

11 Select the mode for the outside area with the **[←]**, **[→]**, **[◀]**, or **[▶]** key.



12 Press the **[OK]** key.

Note

- When you select Photo mode for both inside and outside areas, you cannot select different coarseness and image density.
- When you want to confirm your settings, press the **[Make-Up]** key twice. Then press the **[OK]** key repeatedly until the panel display reaches the setting you want to confirm.

13 If you have selected Photo mode, select the coarseness and the im-

age density with the **[←]**, **[→]**, **[◀]**, or **[▶]** key.

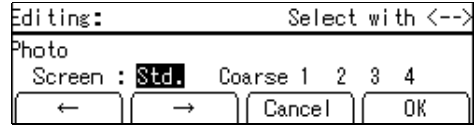

Note

- Four coarseness settings are available:
 - Setting 4: coarsest
 - Setting 3: coarser than setting 2
 - Setting 2: coarser than setting 1
 - Setting 1: coarser than the standard setting

14 Press the **[OK]** key.

15 Set the first command sheet face down on the exposure glass (contact glass) and press the **[Start]** key.

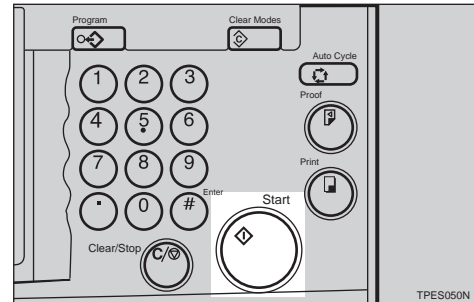

The beeper sounds after the command sheet is scanned.

Note

- Repeat step **15** for the other command sheets.

16 Set the original face down on the exposure glass (contact glass) and press the **[Start]** key.

Make-up Printing With The Optional Document Feeder

Under the following conditions, you should set command sheets and the original on the exposure glass (contact glass).

- When using paste-up originals.
- When the command sheets and original are of different size.

With the optional document feeder, you can designate areas to be edited in Make-up mode within the following limits:

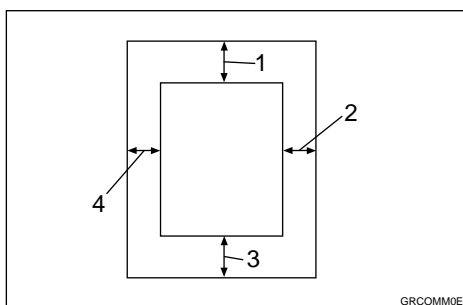

1 = 3 mm, 0.12"

2 = 3 mm, 0.12"

3 = 3 mm, 0.12"

4 = 3 mm, 0.12"

Note

- When using coated paper or transparent paper as a command sheet, set the command sheet and original separately into the document feeder.

1 Press the **[Make-Up]** key.

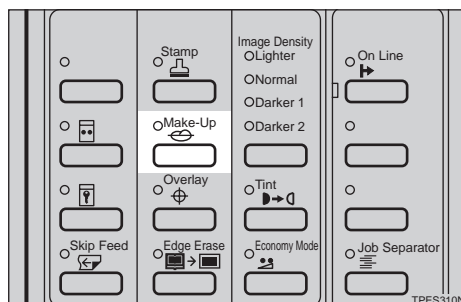

2

2 Make sure that **[1]** is selected. Then press the **[OK]** key.

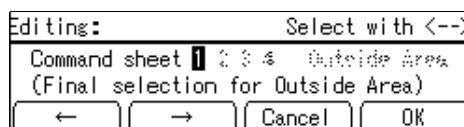

3 Select the frame shape with the **[←]**, **[→]**, **[◀]**, or **[▶]** key.

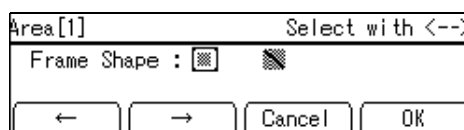

4 Press the **[OK]** key.

2

5 Select the mode for the first command sheet with the [←], [→], [◀], [▶], [△], or [▽] key.

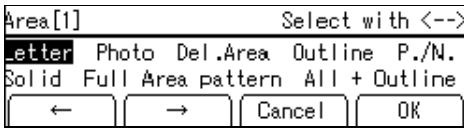

6 Press the [OK] key.

7 If necessary, select the pattern for the first command sheet with the [◀], [▶], [△], or [▽] key. Then press the [OK] key.

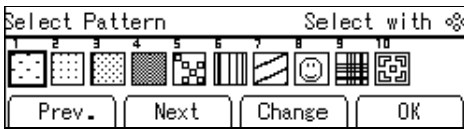

8 If necessary, select the size and direction of the pattern you selected in step 7 with the [←], [→], [◀], or [▶] key.

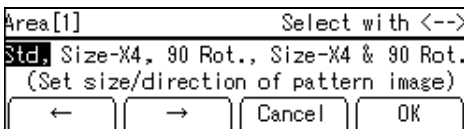

9 Press the [OK] key.

Note

- Follow steps 2 – 9 for the other command sheets.
- You can select a pattern registered with the user tools for only one command sheet.
- To change the value entered, press the [Clear/Stop] key and enter the new value.

10 After you have finished designating modes for all the command sheets, select [Outside Area] with the [←], [→], [◀], or [▶] key. Then press the [OK] key.

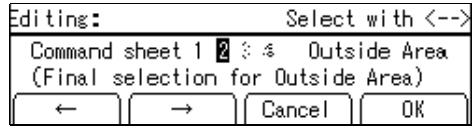

11 Select the mode for the outside area with the [←], [→], [◀], or [▶] key.

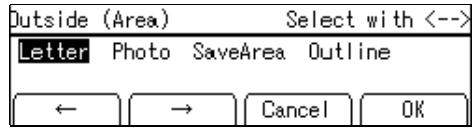

12 Press the [OK] key.

Note

- When you select Photo mode for both inside and outside areas, you cannot select different coarseness and image density.
- When you want to confirm your settings, press the [Make-Up] key twice. Then press the [OK] key repeatedly until the panel display reaches the setting you want to confirm.

13 When you select Photo mode, select the coarseness and image

density with the [←], [→], [◀], or [▶] key.

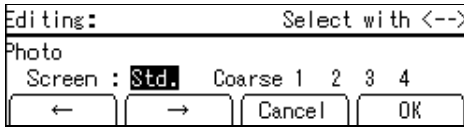

Note

- Four coarseness settings are available:
 - Setting 4: coarsest
 - Setting 3: coarser than setting 2
 - Setting 2: coarser than setting 1
 - Setting 1: coarser than the standard setting

14 Press the [OK] key.

15 Set the command sheets and original face up into the document feeder.

Note

- Make sure that the command sheets are set on the original.

16 Press the [Start] key.

Note

- If a command sheet or an original misfeeds, remove the misfed sheets or original and reset it into the document feeder. It is not necessary to reset the previous command sheets or original.

Make-up Samples

Sample 1

- ① Command Sheet No. 1, Frame shape \square , Designated area: Delete Area mode
- ② Outside area: Letter mode
- ③ Print

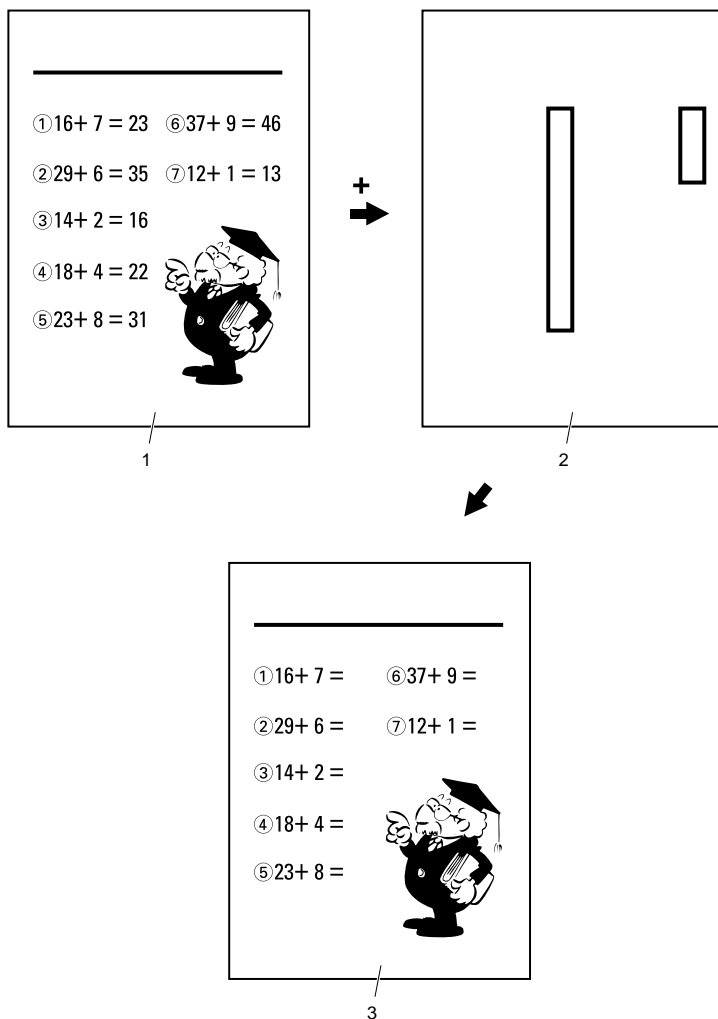

ZM-50

1. Original
2. Command sheet No.1
3. Print

Sample 2

- ① Command Sheet No. 1, Frame shape /, Designated area: All + Outline No. 30
- ② Command Sheet No. 2 Frame shape □, Designated area: All page pattern No. 17
- ③ Outside area: Fn1
- ④ Print

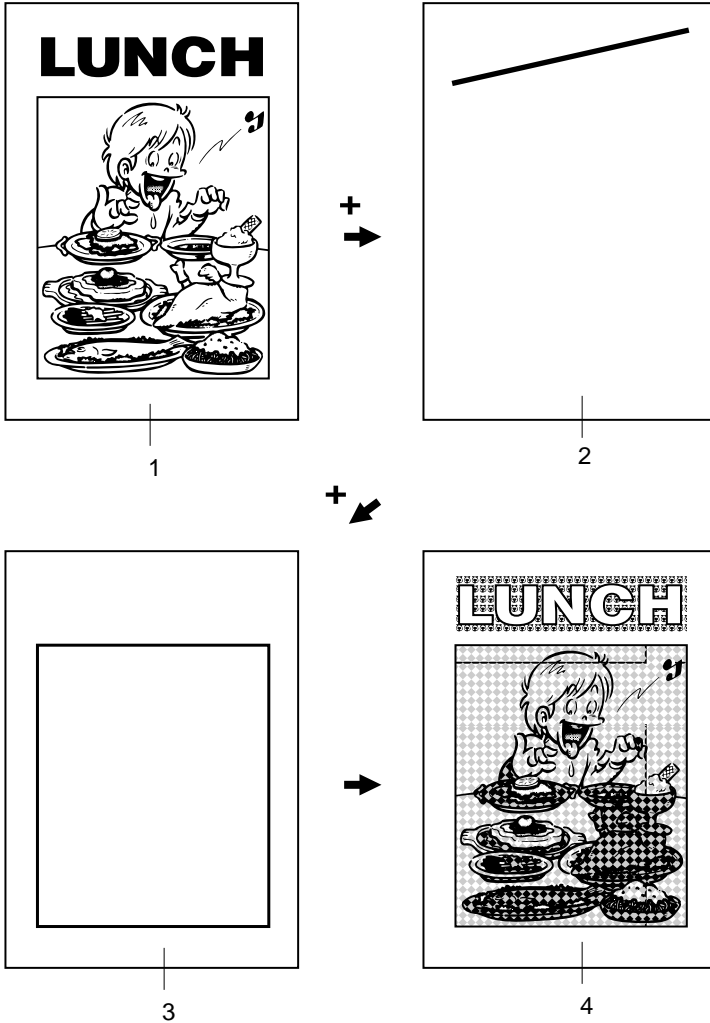

ZM-51

- 1. Original
- 2. Command sheet No.1
- 3. Command sheet No.2
- 4. Print

Sample 3

- ① Print the original as it is
- ② Change the drum unit for color printing
- ③ Command Sheet No. 1, Frame shape , Designated area: All page pattern No. 39
- ④ Outside area: Letter mode
- ⑤ Print

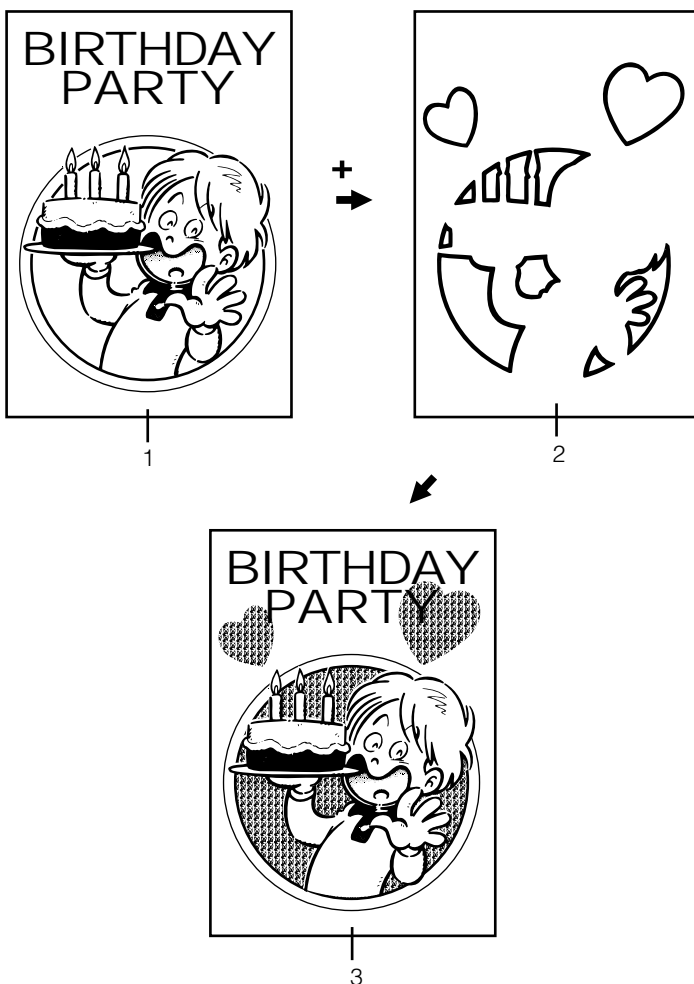

ZM-52

1. Original
2. Command sheet No.1
3. Print

Image Overlay—Merging Images

The machine can merge two different originals onto the same print paper.

Two types of merging are available:

◆ Overlay

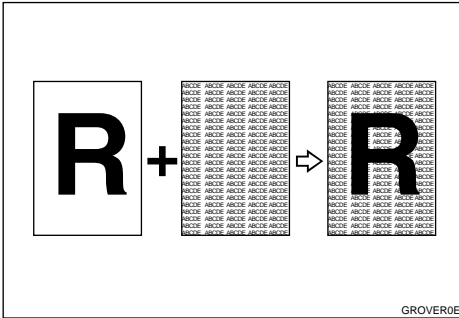

Two different originals are merged onto the same print paper.

◆ Form

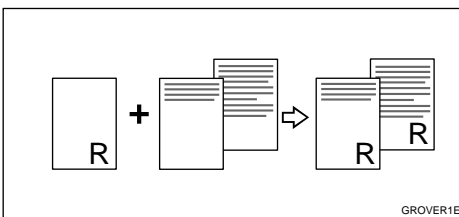

The image of the original which is copied first will be a background image on all copies. The following originals will be copied with this background.

◆ On Line Overlay

The image from the personal computer and the original image can be merged onto the same print paper.

● Limitation

- ❑ The optional memory board is required to use Overlay or Form mode.

- ❑ The optional PC controller is required to use On Line Overlay mode.
- ❑ The original and the image on the personal computer sizes should be the same. Otherwise, you might not get proper print image.

1 Press the [Overlay] key.

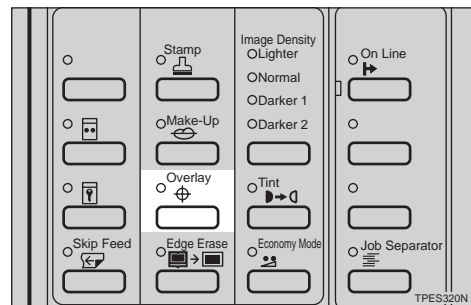

2 Select one of Image Overlay modes with the [←], [→], [◀], or [▶] key.

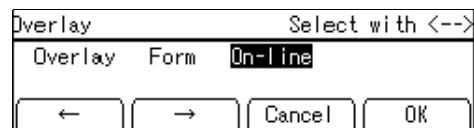

3 Press the [OK] key.

4 Set your originals and press the [Start] key.

Setting originals on the exposure glass (contact glass)

- ① Set the first original on the exposure glass (contact glass).

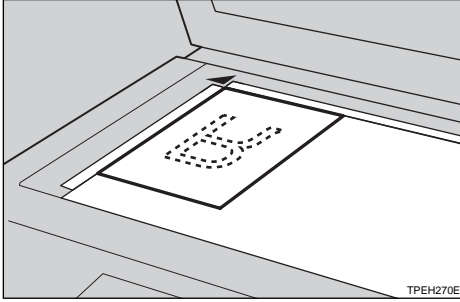

- ② Press the **[Start]** key.

Note

- When you select **[Form]** in step ②, the original for the template should be set first.
- To change the background image in Form mode, press the **[Enter]** key. Then set the next original for the template and press the **[Start]** key.

- ③ Set the next original on the exposure glass (contact glass).

- ④ Press the **[Start]** key.

Note

- When you select **[Form]** in step ②, repeat steps ③ and ④.

Setting originals in the optional document feeder

- ① Set originals in the document feeder.

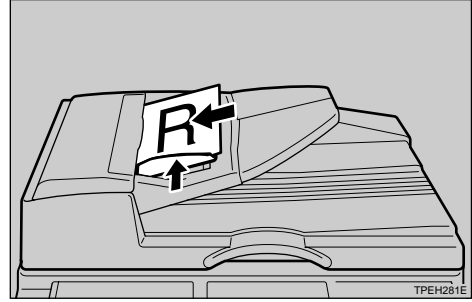

- ② Press the **[Start]** key.

Note

- When you select **[Form]** in step ②, the original for the template should be on the top.
- To change the background image in Form mode, press the **[Enter]** key. Then set the next original for the template and press the **[Start]** key.

Stamping Date—Having The Date Stamped On Your Prints

You can print the date on your prints.

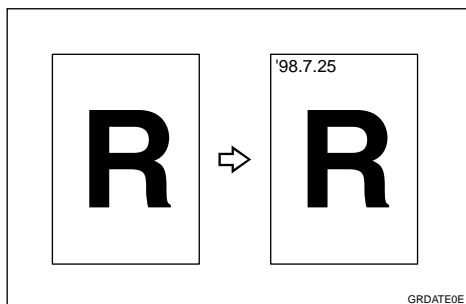

Preparation

Before you use this function, you have to set the machine's internal clock with the user tools. See ⇒ P.148 "1-8 Time Setting".

Limitation

- The optional memory board is required.
- The font size of the date cannot be changed.
- If you select Page Stamping and Stamping Date together, the last stamping direction selected takes priority.

Note

- The default format of Stamping Date is "Month Day Year". You can change this setting with the user tools. See "Date Style Set" in ⇒ P.144 "5. Stamp".
- You can edit the preset Stamping Date position. See ⇒ P.158 "5-11 Position (Date)".
- The Stamping date directions on the panel display and actual print images are as follows:

Stamping Date direction on the display	Print image		

1 Press the **[Stamp]** key.

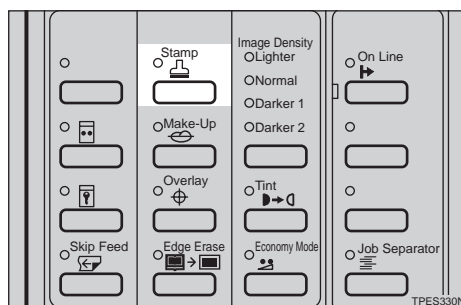

2 Make sure that [Date] is selected.

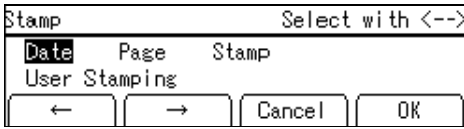

3 Press the [OK] key.

4 Select the desired Stamping Date position and direction with the [←], [→], [◀], or [▶] key.

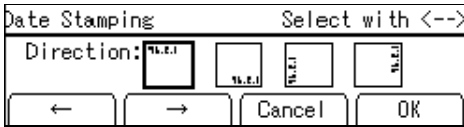

5 Press the [OK] key.

6 Select the [Yes] or [No] key.

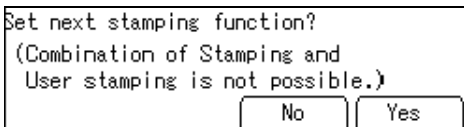

Note

- Press the [Yes] key if you wish to set the other Stamp functions.

7 Set your original and press the [Start] key.

Setting your original (📄) on the exposure glass (contact glass)

1 Set your original as shown in the illustration.

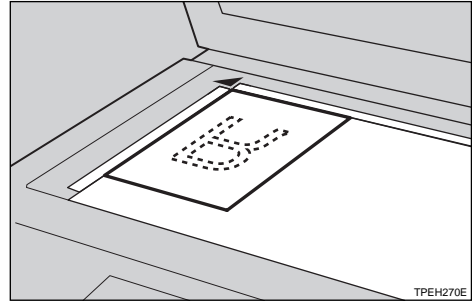

Setting your originals (📄) in the optional document feeder

1 Set your originals as shown in the illustration.

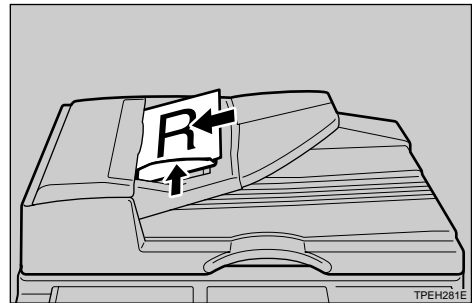

Page Stamping—Having Page Numbers Stamped On Your Prints

You can print page numbers on your prints.

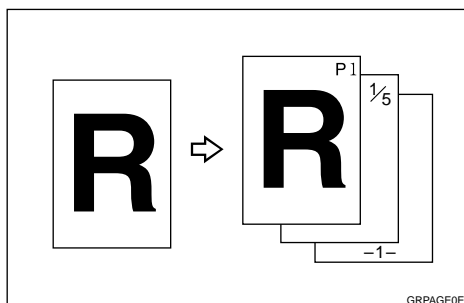

Three numbering formats are available:

- P1, P2,....., P5
- 1/5, 2/5,....., 5/5
- -1-, -2-,....., -3-

Limitation

- The optional memory board is required.
- The size and font of Page Stamping cannot be changed.
- If you select Page Stamping and Stamping Date together, the last stamping direction selected takes priority.

Note

- The Page Stamping direction on the panel display and actual print image are as follows:

Page Stamping direction on the display	Print image

- You can edit the preset page numbering position with the user tools. See ⇒ P.160 “5-14 Position (Page)”.
- [P1, P2,...., P5] is the default format. You can change this default setting with the user tools. See “Type (Page)” in ⇒ P.144 “5. Stamp”.

1 Press the [Stamp] key.

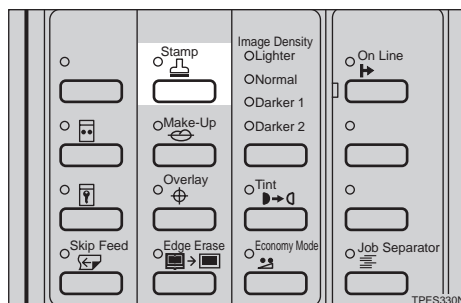

2 Select the [Page] with the [→] or [▷] key.

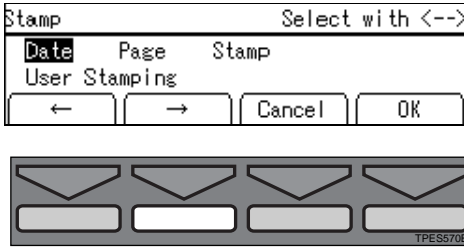

3 Press the [OK] key.

4 Select the desired format with the [←], [→], [◁], or [▷] key.

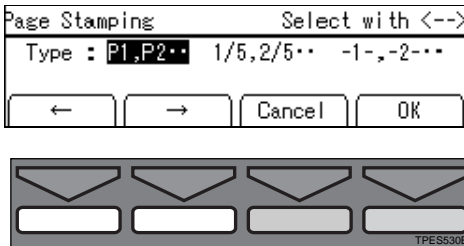

5 Press the [OK] key.

If you selected [P1, P2] or [-1-, -2-]

1 Enter the first page number of original with the [←], [→], [◁], or [▷] key.

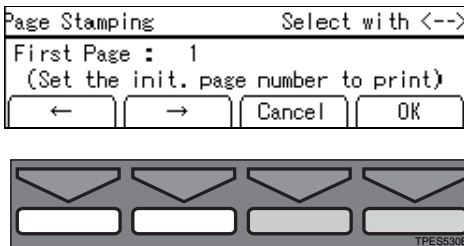

Note

- You can also enter the page number with the Number keys.
- To change the value entered, press the [Clear/Stop] key and enter the new value.

2 Press the [OK] key.

If you selected [1/5, 2/5]

1 Enter the last page number of original with the [←], [→], [◁], or [▷] key.

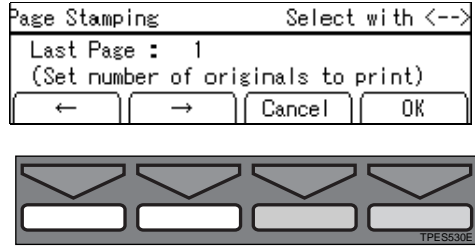

Note

- You can also enter the page number with the Number keys.
- To change the value entered, press the [Clear/Stop] key and enter the new value.

2 Press the [OK] key.

3 Enter the first page number of original with the [←], [→], [◁], or [▷] key.

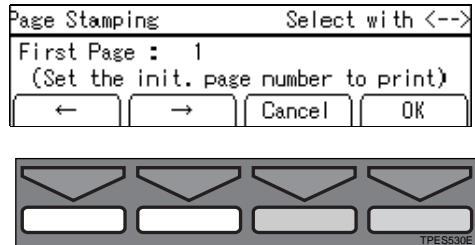

Note

- You can also enter the page number with the Number keys.
- To change the value entered, press the [Clear/Stop] key and enter the new value.

4 Press the [OK] key.

- 6** Select the desired orientation with the [←], [→], [◀], or [▶] key.

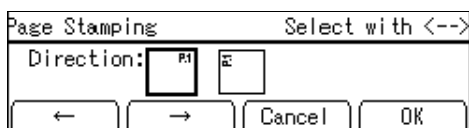

- 7** Press the [OK] key.

- 8** Select the [Yes] or [No] key.

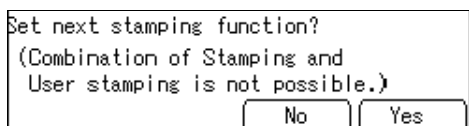

Note

- Press the [Yes] key if you wish to set the other Stamp functions.

- 9** Set your original and press the [Start] key.

Setting your originals (📄) on the exposure glass (contact glass)

- 1** Set the first original as shown in the illustration.

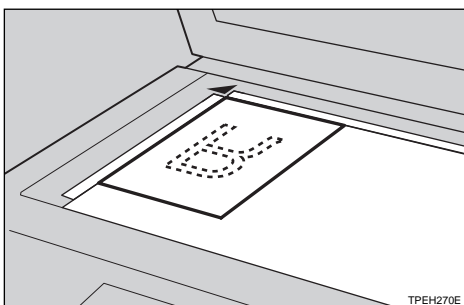

Note

- Repeat step 9 for the other originals.

Setting your originals (📄) in the optional document feeder

- 1** Set your originals as shown in the illustration.

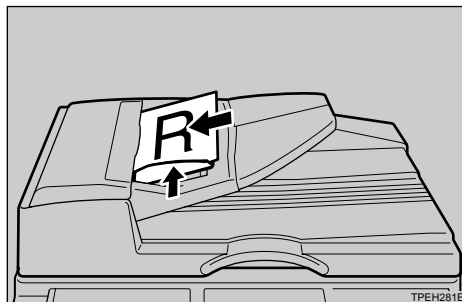

Note

- The first original should be on the top.

Stamping Function—Printing Preset Messages On Your Prints

2

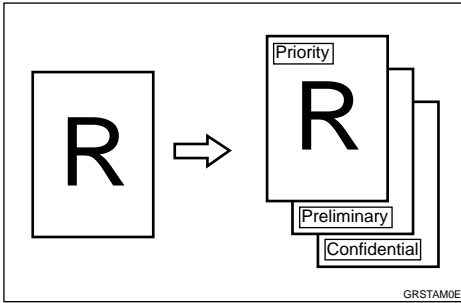

One of the following 3 messages can be stamped on prints.

Confidential

Priority

Preliminary

Limitation

- The optional memory board is required.
- This function cannot be used with User Stamping.
- Only one message can be stamped at a time.

Note

- You can change some Stamping Function settings (preset stamping position, size, or density) with the user tools. See "Type", "Size", "Stamp Density", "Stamp Position", in ⇒ P.144 "5. Stamp".
- The message "Confidential" is selected as a default. You can change this default setting with the user tools. See "Type" in ⇒ P.144 "5. Stamp".

1 Press the [Stamp] key.

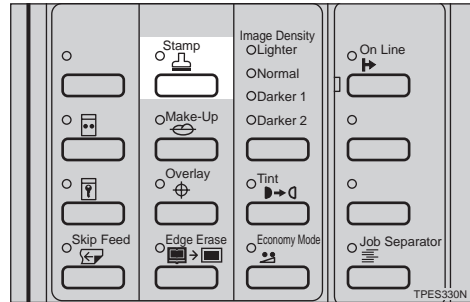

2 Select [Stamp] with the [←], [→], [◀], or [▶] key.

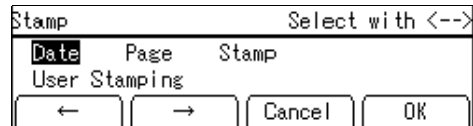

3 Press the [OK] key.

4 Select the desired message with the [←], [→], [◀], or [▶] key.

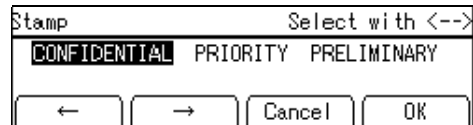

5 Press the [OK] key.

- 6 Select the page to be stamped with the [←], [→], [◀], or [▶] key.

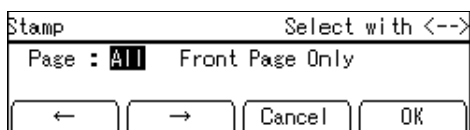

- 7 Press the [OK] key.

- 8 Select the stamping position with the [←], [→], [◀], or [▶] key.



- 9 Press the [OK] key.

- 10 Select the [Yes] or [No] key.

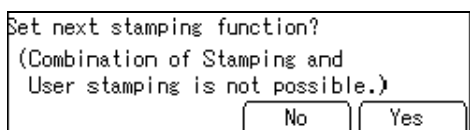

Note

- Press the [Yes] key if you wish to set the other Stamp functions.

- 11 Set your original and press the [Start] key.

Setting your original (📄) on the exposure glass (contact glass)

- 1 Set your original as shown in the illustration.

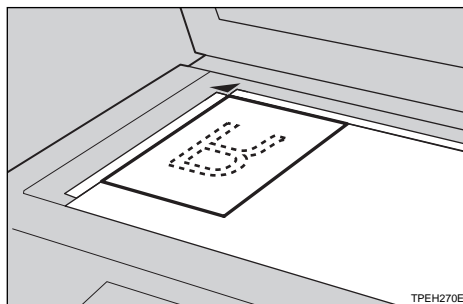

2

Setting your originals (📄) in the optional document feeder

- 1 Set your originals as shown in the illustration.

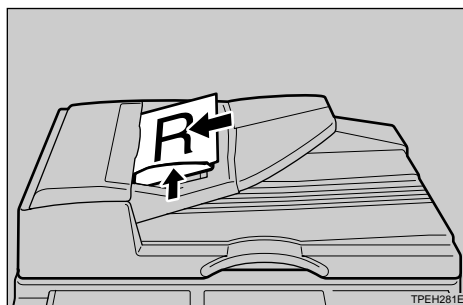

User Stamping—Printing Your Own Messages On Your Prints

Up to 4 messages which you use frequently can be stored in the machine memory. You can have these messages stamped on your prints.

2

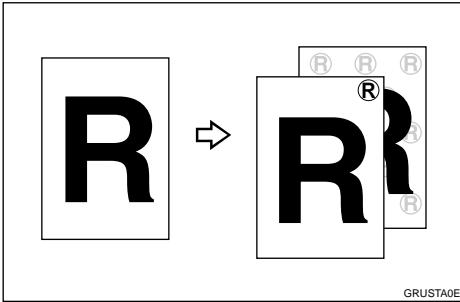

Preparation

You have to store your message with the user tools. See ⇒ P.158 "5-8 Regist. (User)".

Limitation

- The optional memory board is required.
- This function cannot be used with the Stamping Function.
- Only one message can be stamped at a time.
- The registered user stamp cannot be deleted. If you want to change the registered user stamp, overwrite it.

Note

- You can change some User Stamping settings (preset stamping position, size, or density) with the user tools. See "Size (User Stamp)", "Density (User)", "Position (User)" in ⇒ P.144 "5. Stamp".

1 Press the **[Stamp]** key.

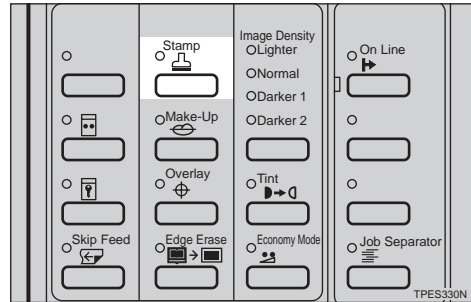

2 Select **[User Stamping]** with the **[←]**, **[→]**, **[◀]**, or **[▶]** key.

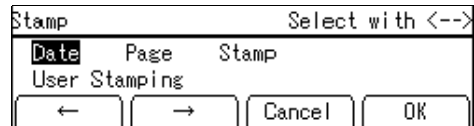

3 Press the **[OK]** key.

4 Select the desired user stamp with the **[←]**, **[→]**, **[◀]**, or **[▶]** key.

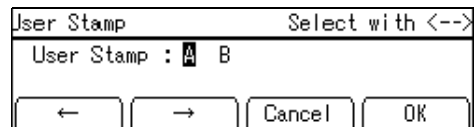

5 Press the **[OK]** key.

- 6 Select the page to be stamped with the [←], [→], [◀], or [▶] key.

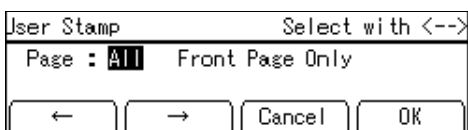

- 7 Press the [OK] key.
- 8 Select the stamping position with the [←], [→], [◀], or [▶] key.

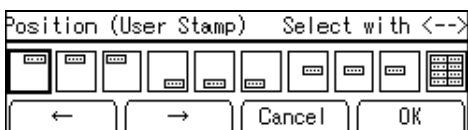

- 9 Press the [OK] key.
- 10 Select the [Yes] or [No] key.

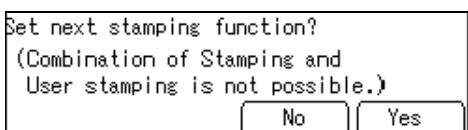

Note

- ☐ Press the [Yes] key if you wish to set the other Stamp functions.

- 11 Set your original and press the [Start] key.

Setting your original (☐) on the exposure glass (contact glass)

- 1 Set your original as shown in the illustration.

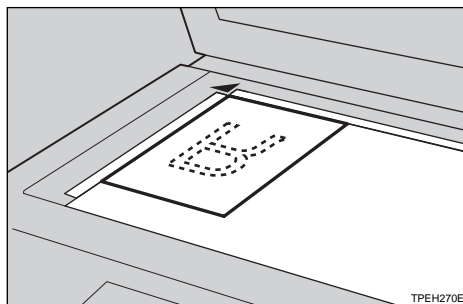

2

Setting your originals (☐) in the optional document feeder

- 1 Set your originals as shown in the illustration.

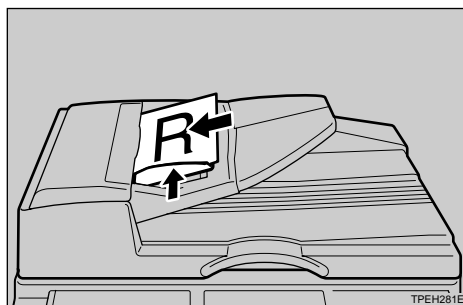

Memory Combine—Combining Originals Into One Print With The Memory Board

You can combine originals in four ways:

❖ 4 One-sided Originals → 1 One-sided Print Of 4 Images

4 one-sided pages are printed onto 1 one-sided sheet, 4 original images on one side.

❖ 8 One-sided Originals → 1 One-sided Print Of 8 Images

8 one-sided pages are printed onto 1 one-sided sheet, 8 original images on one side.

❖ 16 One-sided Originals → 1 One-sided Print Of 16 Images

16 one-sided pages are printed onto 1 one-sided sheet, 16 original images on one side.

❖ Repeating An Image Over The Entire Print

1 original image is printed repeatedly.

💡 Limitation

- The optional memory board is required.

📝 Note

- A separation Line between images can be printed with the user tools. See “Comb. Sep. Line” in ⇒ P.139 “4. Mode Setting”.

Combine 4, 8, or 16 Originals – 4, 8, or 16 One-sided Originals → 1 One-sided Print Of 4, 8, or 16 Images

❖ 4 One-sided Originals → 1 One-sided Print Of 4 Images

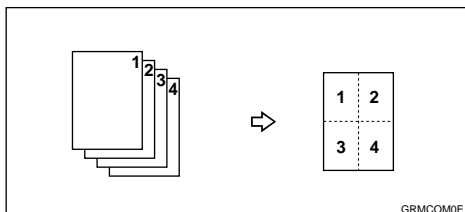

❖ 8 One-sided Originals → 1 One-sided Print Of 8 Images

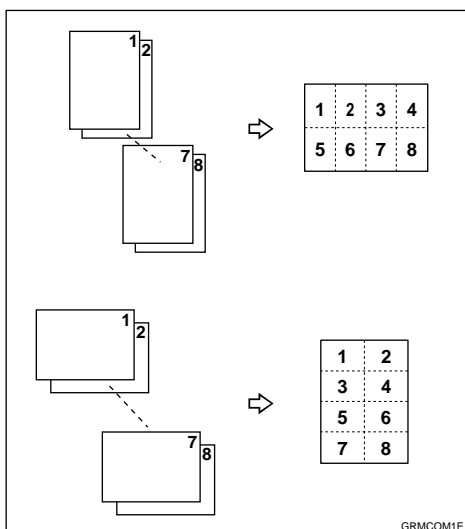

❖ 16 One-sided Originals → 1 One-sided Print Of 16 Images

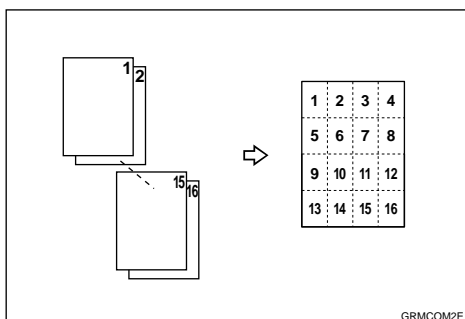

⚠ Limitation













- When your machine is equipped with the optional document feeder, you can use 16 one-sided originals → 1 one-sided print of 16 images mode.

- ❑ If the calculated ratio is under the minimum ratio, it is corrected within the range of the ratio automatically. However, with some ratios, parts of the image might not be copied.
- ❑ The machine cannot copy originals different in size and direction.

 **Note**

- ❑ The number of originals printed (combined) can be 4, 8, or 16.
- ❑ In this mode, the machine selects the reproduction ratio automatically. This reproduction ratio depends on the print paper sizes and the number of originals.
- ❑ When the original is set at a different direction from the print paper, the machine automatically rotates the original image by 90° to match the print paper direction.
- ❑ You can set the machine to cancel Memory Combine mode after finishing your print job with the user tools. See “Cancel Comb” in ⇒ P.139 “4. Mode Setting”.
- ❑ Refer to the following table when you select the original and paper sizes.

❖ **When you set originals in the optional document feeder (Metric version)**













Original \ Paper	A3 	B4 	A4  	B5  	A5  
A3 	*3	*3	*2	*2	*1
B4 	--	*3	*3	*2	*2
A4  	--	--	*3	*3	*2
B5  	--	--	--	*3	*3

*1 You can use these original and paper sizes in Combine 4, 8, 16 Originals mode.

*2 You can use these original and paper sizes in Combine 4, 8 Originals mode.

*3 You can use these original and paper sizes in Combine 4 Originals mode.

❖ **When you set originals in the optional document feeder (Inch version)**













Original \ Paper	11" × 17" 	8 ¹ / ₂ " × 14" 	8 ¹ / ₂ " × 11"  	8 ¹ / ₂ " × 5 ¹ / ₂ "  
11" × 17" 	*3	*3	*2	*1
8 ¹ / ₂ " × 14" 	--	*3	*3	*2
8 ¹ / ₂ " × 11"  	--	--	*3	*2
5 ¹ / ₂ " × 8 ¹ / ₂ "  	--	--	--	*3

*1 You can use these original and paper sizes in Combine 4, 8, 16 Originals mode.

*2 You can use these original and paper sizes in Combine 4, 8 Originals mode.

*3 You can use these original and paper sizes in Combine 4 Originals mode.











❖ When you set originals on the exposure glass (contact glass) (Metric version)

Original \ Paper	A3 	B4 	A4  	B5  
A3 	*2	*2	*1	*1
B4 	--	*2	*2	*1
A4  	--	--	*2	*2
B5  	--	--	--	*2

*1 You can use these original and paper sizes in Combine 4, 8 Originals mode.

*2 You can use these original and paper sizes in Combine 4 Originals mode.

❖ When you set originals on the exposure glass (contact glass) (Inch version)

Original \ Paper	11" × 17" 	8 1/2" × 14" 	8 1/2" × 11"  
11" × 17" 	*2	*2	*1
8 1/2" × 14" 	--	*2	*2
8 1/2" × 11"  	--	--	*2
5 1/2" × 8 1/2"  	--	--	--

*1 You can use these original and paper sizes in Combine 4, 8 Originals mode.

*2 You can use these original and paper sizes in Combine 4 Originals mode.

1 Press the [Combine] key.

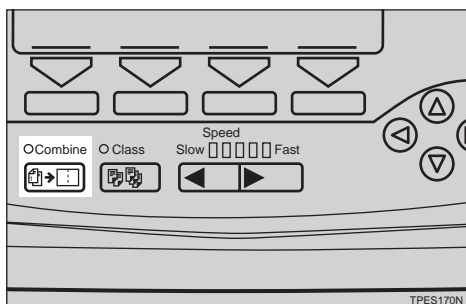

2 Select [Memory Combine] with the [←] or [↵] key.

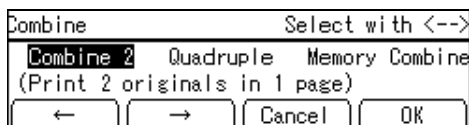

3 Press the [OK] key.

4 Select one of the desired combine modes.

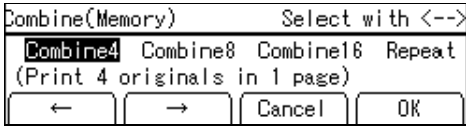



5 Press the [OK] key.

6 Set your originals.

Setting your original () on the exposure glass (contact glass)

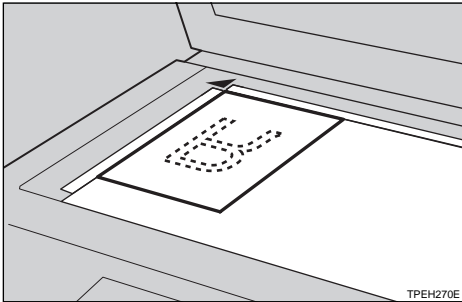
1 Set your original as shown in the illustration.



Setting your originals () in the optional document feeder

1 Set your originals as shown in the illustration.

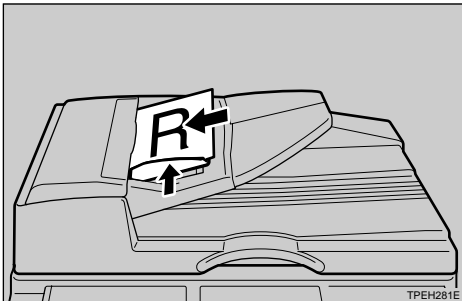

7 Press the [Start] key.

Note

- ❑ Even if the number of originals is less than the number required in the selected mode, prints can be made, as shown in the illustration. In this case, press the **[Enter]** key after all the originals have been scanned.

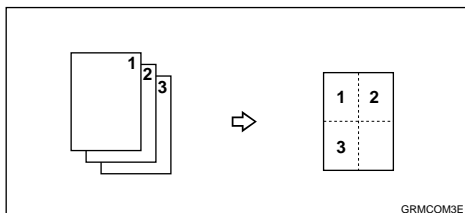

- ❑ When you set original on the exposure glass (contact glass) or set one sheet at a time in the optional document feeder, repeat steps **6** and **7**. After setting the last original, press the **[Enter]** key and the **[Start]** key.

Repeat—Repeating An Image Over The Entire Print

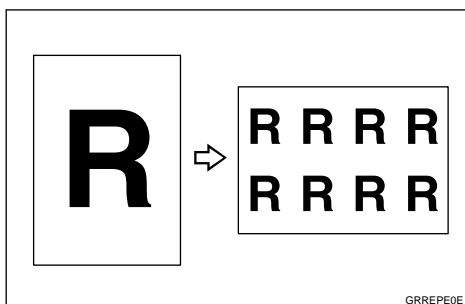
**Limitation**

- ❑ Part of the repeated image might not be printed depending on paper size, direction or reproduction ratio.

Note

- ❑ The number of repeated images depends on the original and paper size, and reproduction ratio.

☐ The original and paper setting direction and the number of repeated images are as follows:

❖ For example, when you use A4 ☐ originals and A3 ☐ paper.

The number of repeated images	Reproduction ratio	Print image
4	71 %	 <small>GRREPE3E</small>

❖ For example, when you set A5 ☐ originals in the optional document feeder and you use A3 ☐ paper.

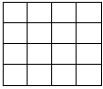
The number of repeated images	Reproduction ratio	Print image
16	50 %	 <small>GRREPE4E</small>

❖ For example, when you use 8 1/2" x 11" ☐ originals and 11" x 17" ☐ paper.

The number of repeated images	Reproduction ratio	Print image
2	100 %	 <small>GRREPE5E</small>

❖ For example, when you set A5 ☐ originals in the optional document feeder and you use A4 ☐ paper.

The number of repeated images	Reproduction ratio	Print image
8	50 %	 <small>GRREPE6E</small>

- 1 Press the **[Combine]** key.

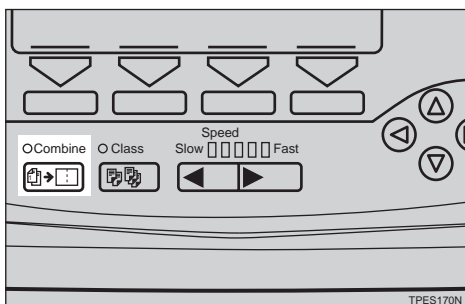

- 2 Select **[Memory Combine]** with the **[←]** or **[↶]** key.

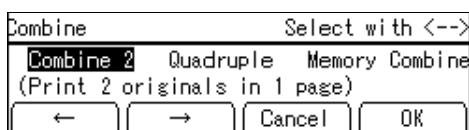

- 3 Press the **[OK]** key.

- 4 Select **[Repeat]** with the **[←]** or **[↶]** key.

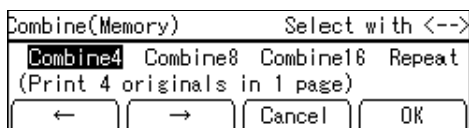

- 5 Press the **[OK]** key.

- 6 Select the proper reproduction ratio.

Reference

See ⇒ P.30 "Preset Reduce/Enlarge—Reducing And Enlarging Using Preset Ratios".

- 7 Set your original.

Setting your original () on the exposure glass (contact glass)

- 1 Set your original as shown in the illustration.

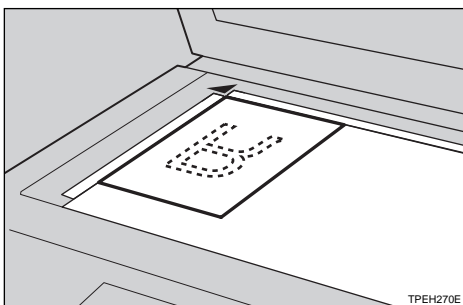

Setting your originals () in the optional document feeder

- 1 Set your originals as shown in the illustration.

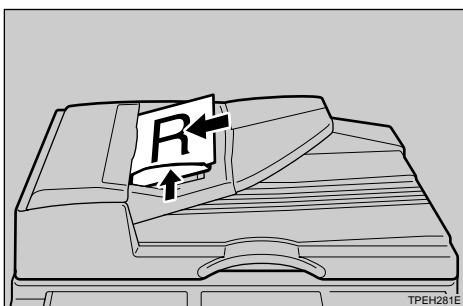

- 8 Press the **[Start]** key.

3. USER TOOLS

Accessing The User Tools

This section is for the key operators in charge of this machine. You can change or set the machine's default settings.

1 Press the **[User Tools]** key.

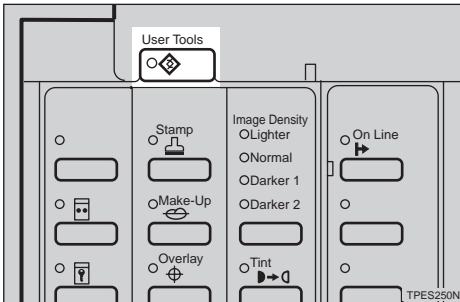

2 Select the desired user tools menu. See ⇒ P.135 "User Tools Menu".

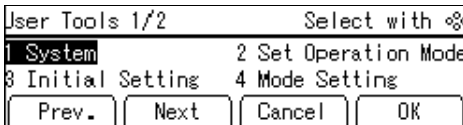

Using the **[<]**, **[>]**, **[Δ]**, or **[∇]** key

1 Search for the desired user tool number (1 to 6) with the **[<]**, **[>]**, **[Δ]**, or **[∇]** key.

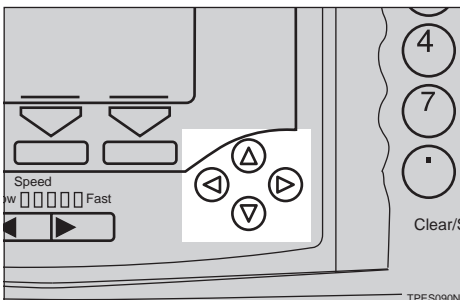

Note

[Next]: Press to go to the next page.

[Prev.]: Press to go back to the previous page.

2 Press the **[OK]** key.

3 Search for the desired user tool number of each function with the **[<]**, **[>]**, **[Δ]**, or **[∇]** key.

4 Press the **[OK]** key.

Using the number keys

1 Enter the desired user tool number (1 to 6) with the Number keys.

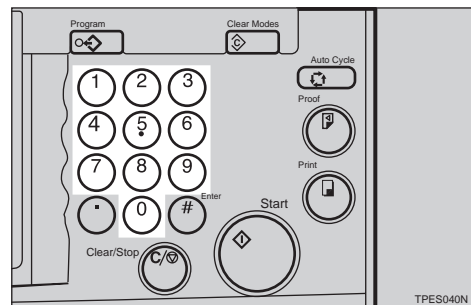

2 Press the **[OK]** or **[Enter]** key.

3 Enter the desired user tool number of each function with the Number keys.

4 Press the **[OK]** or **[Enter]** key.

3 Change the settings by following the instructions on the panel display. Then press the **[OK]** key.

Note

To change the value entered, press the **[Clear/Stop]** key before

pressing the **[OK]** key. Then enter the new value.

- [Cancel]**: Press to return to the previous menu without changing any data.

4 Press the **[User Tools]** key to return to the Ready condition.

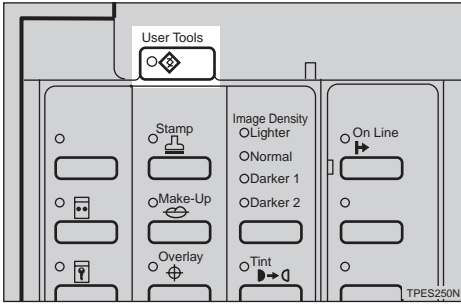

Note







- The settings are not canceled even if the main switch is turned off or the **[Clear Modes]** key is pressed.
- You can also return to the Ready condition by pressing the **[Cancel]** key.





User Tools Menu

Reference



For how to access the user tools, see ⇒ P.133 “Accessing The User Tools”.



1. System

No.	Mode	Description
1	Auto Reset	<p>The machine returns to its initial condition automatically after your job is finished. The automatic reset time can be set from 1 to 5 minutes or off (0 minute).</p> <p> Note <input type="checkbox"/> Default: off</p>
2	R. Counter Display	<p>Use to display the total number of masters and prints.</p> <p> Note <input type="checkbox"/> A trial print delivered to the paper delivery tray after pressing the [Start] key will not be counted.</p>
3	Reset R. Counter	<p>Choose whether the total number of masters and prints is reset.</p> <p> Note <input type="checkbox"/> Default: Not clear</p>
4	Set User Code	<p>Selects User Code mode. For details about User Code mode, see ⇒ P.146 “6. Set User Code (s)”.</p> <p> Note <input type="checkbox"/> Default: Not to use</p>
6	mm/inch	<p>Choose the units of measurement shown on the panel display.</p> <p> Note <input type="checkbox"/> Default:</p> <ul style="list-style-type: none"> • Metric version: mm • Inch version: inch
7	Language on LCD	<p>The language used for panel display messages can be selected.</p> <p> Note <input type="checkbox"/> Default: English</p>



No.	Mode	Description
8	Time Setting	<p>Use to set the machine's internal clock.</p> <p> Note</p> <p><input type="checkbox"/> The clock must be adjusted if you change the clock to daylight saving time/summer time, or return to standard time.</p> <p> Reference</p> <p>For how to set the clock, see ⇒ P.148 "1-8 Time Setting".</p>
9	Auto Online	<p>Specifies whether On Line mode is automatically selected when the machine detects the data from the personal computer.</p> <p> Note</p> <p><input type="checkbox"/> Default: ON</p>
10	Data Print	<p>Use to print out the following data.</p> <p> Note</p> <p><input type="checkbox"/> Available settings:</p> <ul style="list-style-type: none"> • Log Data (Number of prints made, how many times paper misfeeds occur and so on.) • Reset Counters (Number of prints and master made under each user code) • Store Class (Registered number of students in each class.)







2. Set Operation Modes



No.	Mode	Description
1	Min. Quantity	<p>The minimum print quantity can be set between 0 and 9999.</p> <p>Example: If you specify 20 as minimum number of prints, runs of 20 or more prints will be accepted, runs of less than 20 prints will not be accepted.</p> <p> Note</p> <p><input type="checkbox"/> Default: 0</p>
2	Max. Quantity	<p>The maximum print quantity can be set between 0 and 9999.</p> <p> Note</p> <p><input type="checkbox"/> Default: 9999</p>

No.	Mode	Description
3	Copy Count Display	The counter can be set to show the number of prints made (Up), or the number of prints remaining to be made (Down).  Note <input type="checkbox"/> Default: Down
5	Panel Beeper	Turns the beeper on or off.  Note <input type="checkbox"/> Default: STD. (standard) <input type="checkbox"/> Available settings: <ul style="list-style-type: none"> • ALL ON (The beeper sounds when you press a key or when warning messages appear on the panel display.) • STD. (When you press a key, the beeper does not sound. When warning messages appear on the panel display, the beeper sounds.) • ALL OFF (The beeper does not sound when you press keys or when warning messages appear on the panel display.)
6	LCD Contrast	You can adjust the brightness of the panel display.





3. Initial Setting







No.	Mode	Description
1	Paper Type	Specifies the paper type at power on.  Note <input type="checkbox"/> Default: Std. (Standard)
2	MSTR Makg. Density	Specifies the image density at power on.  Note <input type="checkbox"/> Default: Std. (Standard)
3	Original Priority	Specifies the original mode at power on.  Note <input type="checkbox"/> Default: Letter







No.	Mode	Description
4	Reproduction Ratio	Adjust a fixed reproduction ratio between 50 and 200 %.  Note <input type="checkbox"/> Default: <ul style="list-style-type: none"> • Metric version: 71 %, 82 %, 87 %, 93 %, 100 %, 115 %, 122 %, 141 % • Inch version: 65 %, 74 %, 77 %, 93 %, 100 %, 121 %, 129 %, 155 %  Reference For how to set the ratios, see ⇒ P.148 “3-4 Reproduction Ratio”.
5	Class Enter No.	Before using All Class or Auto Class mode, register the number of students in each class with this function.  Note <input type="checkbox"/> Default: Class 1 – 4: 30 Class 5 – 12: 0 <input type="checkbox"/> You can store student numbers for up to 9 grades with 12 classes in each, giving a maximum of 108 classes. Each class can have up to 9999 students.  Reference For how to register the number of students, see ⇒ P.149 “3-5 Class Enter No.”.
6	Photo (Lightness)	Specifies the lightness in Photo or Letter/Photo mode when you press the [Original] key.  Note <input type="checkbox"/> Default: Std. (Standard)
7	Photo (Screen)	Specifies the screen image in Photo mode when you press the [Original] key.  Note <input type="checkbox"/> Default: Std. (Standard)
8	Tint Mode ON/OFF	Specifies whether Tint mode is selected at power on.  Note <input type="checkbox"/> Default: OFF



No.	Mode	Description
9	Margin Erase Area	<p>Adjust the erase edges margin.</p> <p> Note <input type="checkbox"/> Default: 2 mm, 0.1"</p> <p> Reference For how to adjust the erase edges area, see ⇒ P.150 "3-9 Margin Erase Area".</p>
10	Ppr. Size [On-line]	<p>Specifies the paper size when you press the [On Line] key.</p> <p> Note <input type="checkbox"/> Default: Auto</p>





4. Mode Setting

No.	Mode	Description
1	Auto Cycle ON/OFF	<p>Specifies whether Auto Cycle mode is selected at power on.</p> <p> Note <input type="checkbox"/> Default: OFF</p>
2	Class Manual Set	<p>You can use one original or multiple originals in Manual Class mode.</p> <p> Note <input type="checkbox"/> Default: Std. (One original)</p>
3	Ignore Paper Size	<p>If you are making prints on non-standard paper and the original image does not entirely appear on the print, set paper size detection to "Ignore". The machine will not detect the length of paper.</p> <p> Note <input type="checkbox"/> Default: Not to Ignore</p>
4	No Orig. Size (ADF)	<p>When you set long originals in the optional document feeder, set original detection to "Ignore". The machine will not detect the original size.</p> <p> Note <input type="checkbox"/> Default: Not to Ignore</p>
5	No Orig. Size	<p>When you set originals of non standard sizes on the exposure glass (contact glass), set original detection to "Ignore". The machine will not detect the original size.</p> <p> Note <input type="checkbox"/> Default: Not to Ignore</p>

No.	Mode	Description
6	Background ON/OFF	<p>When you make prints in Photo, Letter/Photo, or Tint mode, the background of the prints might become dirty. Turn Background On to improve the clarity of your prints.</p> <p> Note</p> <p><input type="checkbox"/> Default: w/o back. correction (off)</p>
7	Longer Paper	<p>You can select whether you can use paper longer than 432 mm, 17.0" or not.</p> <p> Note</p> <p><input type="checkbox"/> Default: Not to use</p>
8	Combine	<p>If you select "Automatic (Auto Combine mode)", you can make two or four identical images on the one sheet by pressing the [Combine] key and [Start] key.</p> <p> Note</p> <p><input type="checkbox"/> Default: Normal (Combine Originals mode)</p> <p> Reference</p> <p>For how to use Auto Combine mode, see ⇒ P.68 "Auto Combine Mode—Having Images Repeated On One Print".</p>
9	Comb. Sep. Line	<p>You can select a separation line in Memory Combine mode.</p> <p> Limitation</p> <p><input type="checkbox"/> You can use this function only when you have an optional memory board.</p> <p> Note</p> <p><input type="checkbox"/> Default: None</p> <p><input type="checkbox"/> Available settings:</p> <div data-bbox="522 1271 982 1464" style="border: 1px solid black; padding: 5px; margin: 10px 0;"> </div> <ul style="list-style-type: none"> • a = None • b = Solid • c = Broken 1 • d = Broken 2 • e = Crop Marks

No.	Mode	Description
10	Cancel Comb.	<p>Specifies whether Combine Originals or Memory Combine mode is cleared after finishing your print job.</p> <p> Note</p> <p><input type="checkbox"/> Default: Not to cancel</p>
11	No. of Skip Feed	<p>Specifies the number of drum rotations in Skip Feed mode at power on. You can also select whether you can change the number of drum rotations temporarily when you press the [Skip Feed] key. See ⇒ P.70 “Skip Feed Printing”.</p> <p> Note</p> <p><input type="checkbox"/> Default:</p> <ul style="list-style-type: none"> • Panel display: Display • Number of Skip Feed: 2 <p> Reference</p> <p>For how to change number of rotations, see ⇒ P.151 “4-11 No. of Skip Feed”.</p>
12	Idling for Q.start	<p>When you use the Manual Quality Start function, you can select how many times the drum unit idles.</p> <p> Note</p> <p><input type="checkbox"/> Default: 45</p>
13	Setting Q.start	<p>If the machine is not used for a long period of time, the ink on the drum might dry causing image quality to deteriorate. The Auto Quality Start function automatically recovers image density quality after a selected time has passed. If Auto Quality Start is set to “Not to use”, you can regain print quality by making a few extra prints or you can use Manual Quality Start mode.</p> <p> Note</p> <p><input type="checkbox"/> Default: To use</p>
14	No. of Q.start	<p>You can select how many times the drum unit idles after the following time periods have passed in Auto Quality Start mode.</p> <p> Note</p> <p><input type="checkbox"/> Default: See ⇒ P.152 “4-14 No. of Q.start”.</p> <p><input type="checkbox"/> To increase the print image density, increase the number of drum rotations, and vice versa.</p> <p> Reference</p> <p>For how to change the number of idle spins, see ⇒ P.152 “4-14 No. of Q.start”.</p>







No.	Mode	Description
15	Deflector Angle	<p>You can change the angle of the wing guide depending on the paper type you use.</p> <p> Note</p> <ul style="list-style-type: none"> <input type="checkbox"/> Default: Auto <input type="checkbox"/> Available settings: <ul style="list-style-type: none"> • Up (Select this setting when standard thickness or thin paper misfeeds at the paper exit section occur frequently.) • Down (Select this setting when A4 – B5, 8¹/₂" × 11" thick paper is not delivered properly to the paper delivery tray.)
16	Manual Class	<p>When you do not use the Job Separation function, you can select the machine's condition after each printing set is fed out to the paper delivery tray.</p> <p> Note</p> <ul style="list-style-type: none"> <input type="checkbox"/> Default: Stop <input type="checkbox"/> Available settings: <ul style="list-style-type: none"> • Start printing automatically (After the last page of each printing set is fed out to the paper delivery tray, the machine stops for a few seconds. Then, the next cycle begins.) • Stop (After the last page of each printing set is fed out to the paper delivery tray, the machine stops. If you press the [Print] key, the next cycle begins.)
17	Auto Separate	<p>Specifies whether Job Separation mode is automatically carried out when you make prints in All Class, Auto Class, Manual Class, or Class mode.</p> <p> Note</p> <ul style="list-style-type: none"> <input type="checkbox"/> Default: ON











No.	Mode	Description
18	Ink/Master Left	<p>Specifies whether you can check the amount of ink and master.</p> <p> Note</p> <p><input type="checkbox"/> Default: OFF</p> <p><input type="checkbox"/> Available settings:</p> <ul style="list-style-type: none"> • OFF (You cannot check the remaining amount of ink or master.) • ON (When the remaining amount of ink or master is less than half, the panel display indicates these amounts when you turn on the main switch.) • Check remaining volume (You can see the remaining amounts of ink and master regardless of these amounts.)
19	Type of Paper	<p>When one kind of paper misfeeds occur frequently, you can register its paper type in [User 1] or [User 2].</p> <p> Reference</p> <p>For how to register special paper type, see ⇒ P.154 “4-19 Type of Paper”.</p>
20	Auto Rotation	<p>When the direction in which your original is set is different from that of the paper, and your machine is equipped with the optional memory board, the machine automatically rotates the original image by 90° to match the paper direction. You can cancel this setting.</p> <p> Note</p> <p><input type="checkbox"/> Default: ON</p>
21	Master Cut Length	<p>The machine determines the master length according to the original set number in the optional document feeder and the paper sizes. If you wish to use A3/11" × 17" master regardless of the original set number and the paper sizes, select “A3”.</p> <p> Note</p> <p><input type="checkbox"/> Default: Auto</p>





5. Stamp

 **Note**



You can use these functions only when you have an optional memory board.









No.	Mode	Description
1	Type	<p>You can change the message selected at power on in the Stamping function.</p> <p> Note</p> <p><input type="checkbox"/> Default: Confidential</p>
2	Size	<p>You can edit the preset stamp sizes.</p> <p> Note</p> <p><input type="checkbox"/> Default: Standard (about 32 × 64 mm)</p> <p><input type="checkbox"/> Adjustment values:</p> <ul style="list-style-type: none"> • Double size • 4 (4 times) • 8 (8 times)
3	Stamp Density	<p>You can select the style of the stamps.</p> <p> Note</p> <p><input type="checkbox"/> Default: Solid-fill</p>
4	Stamp Position	<p>You can edit the preset stamp position co-ordinates.</p> <p> Note</p> <p><input type="checkbox"/> Default: See ⇒ P.154 “5-4 Stamp Position”.</p> <p><input type="checkbox"/> Available settings: See ⇒ P.154 “5-4 Stamp Position”.</p> <p> Reference</p> <p>For how to adjust the stamp position, see ⇒ P.154 “5-4 Stamp Position”.</p>
5	Size (User Stamp)	<p>You can edit the preset user stamp sizes.</p> <p> Note</p> <p><input type="checkbox"/> Default: Standard (about 32 × 64 mm)</p> <p><input type="checkbox"/> Available settings:</p> <ul style="list-style-type: none"> • Double size • 4 (4 times) • 8 (8 times)

No.	Mode	Description
6	Density (User)	<p>You can select the style of the user stamps.</p> <p> Note</p> <ul style="list-style-type: none"> <input type="checkbox"/> Default: Solid-fill
7	Position (User)	<p>You can edit the preset user stamp position co-ordinates.</p> <p> Note</p> <ul style="list-style-type: none"> <input type="checkbox"/> Default: See ⇒ P.156 “5-7 Position (User)”. <input type="checkbox"/> Available settings: See ⇒ P.156 “5-7 Position (User)”. <p> Reference</p> <p>For how to adjust the user stamp position, see ⇒ P.156 “5-7 Position (User)”.</p>
8	Regist. (User)	<p>You can register user stamps.</p> <p> Note</p> <ul style="list-style-type: none"> <input type="checkbox"/> Registered user stamps can not be deleted. If you want to change a registered user stamp, overwrite it. <p> Reference</p> <p>For how to register a user stamp, see ⇒ P.158 “5-8 Regist. (User)”.</p>
9	Date Style Set	<p>You can select the style of the date stamp.</p> <p> Note</p> <ul style="list-style-type: none"> <input type="checkbox"/> Default: Month Day Year
10	Date Position Set	<p>You can select the date stamp direction at power on in Stamping Date mode.</p> <p> Note</p> <ul style="list-style-type: none"> <input type="checkbox"/> Default: Upper left
11	Position (Date)	<p>You can edit the preset date stamp position co-ordinates.</p> <p> Note</p> <ul style="list-style-type: none"> <input type="checkbox"/> Default: See ⇒ P.158 “5-11 Position (Date)”. <input type="checkbox"/> Available settings: See ⇒ P.158 “5-11 Position (Date)”. <p> Reference</p> <p>For how to adjust the date stamping position, see ⇒ P.158 “5-11 Position (Date)”.</p>
12	Type (Page)	<p>You can select the page numbering style at power on in Page Stamping mode.</p> <p> Note</p> <ul style="list-style-type: none"> <input type="checkbox"/> Default: P1, P2

No.	Mode	Description
13	Direction (Page)	<p>You can select the page numbering direction at power on in Page Stamping mode.</p> <p> Note</p> <p><input type="checkbox"/> Default:</p> <ul style="list-style-type: none"> • When you select [P1, P2] or [1/5, 2/5] with the “Type (Page)” user tool: Upper right • When you select [-1-, -2-] with the “Type (Page)” user tool: Down center
14	Position (Page)	<p>You can edit the preset page numbering position co-ordinates.</p> <p> Note</p> <p><input type="checkbox"/> Default: See ⇒ P.160 “5-14 Position (Page)”.</p> <p><input type="checkbox"/> Available settings: See ⇒ P.160 “5-14 Position (Page)”.</p> <p> Reference</p> <p>For how to adjust the page numbering position, see ⇒ P.160 “5-14 Position (Page)”.</p>
15	Make/Chg. Pattern	<p>Make your own background pattern in Make-up mode.</p> <p> Note</p> <p><input type="checkbox"/> You can edit the 40 preset patterns.</p> <p> Reference</p> <p>For how to change the background pattern, see ⇒ P.161 “5-15 Make/Chg. Pattern”.</p>

6. Set User Code (s)

<p> User Code</p> <p>If the machine is set to use the User Code function, operators must input their user codes before the machine can operate. The machine keeps count of the number of copies made under each user code. Turn on User Code mode with the “Set User Code (s)” user tool. You can also turn on Key Operator Code mode. In Key Operator Code mode, only the selected key operator can use all the functions below.</p>		
1	Check Counter	<p>You can check the number of masters and copies made under each user code.</p> <p> Reference</p> <p>For how to check the number of masters and copies, see ⇒ P.162 “6-1 Check Counter”.</p>

2	Reset Counters	<p>You can clear each or all user codes' counters.</p> <p> Note</p> <ul style="list-style-type: none"> <input type="checkbox"/> Default: Single <p> Reference</p> <p>For how to clear the number of masters and copies, see ⇒ P.163 "6-2 Reset Counters".</p>
3	Reg. User Code	<p>You can register user codes.</p> <p> Note</p> <ul style="list-style-type: none"> <input type="checkbox"/> Up to 20 user codes (up to 4 digits) can be registered.
4	Chg. User Code	<p>You can change user codes.</p> <p> Note</p> <ul style="list-style-type: none"> <input type="checkbox"/> The number of copies made under the old code is added to that made under the new user code. <p> Reference</p> <p>For how to change the user codes, see ⇒ P.163 "6-4 Chg. User Code".</p>
5	Del. User Code	<p>You can delete user codes.</p> <p> Note</p> <ul style="list-style-type: none"> <input type="checkbox"/> The number of copies made under the deleted code is also deleted. <p> Reference</p> <p>For how to delete the user codes, see ⇒ P.164 "6-5 Del. User Code".</p>
6	Key Operator Code	<p>Sets Key Operator Code mode.</p> <p> Note</p> <ul style="list-style-type: none"> <input type="checkbox"/> Default: Not to use
7	Reg/Chg Key-OpCode	<p>You can register or change key operator codes. (up to 4 digits)</p>
8	Restricted Access	<p>In Key Counter mode, you have to set the key counter before making prints. (To turn on Key Counter mode, contact your service representative.) If Key Counter mode is on, Restricted Access is turned on (To use) automatically. If you turn Restricted Access off (Not to use), you can make prints without inserting the key counter.</p> <p> Note</p> <ul style="list-style-type: none"> <input type="checkbox"/> Default: Not to use

User Tool Menus In Detail

1-8 Time Setting

1 Press the **[User Tools]** key.

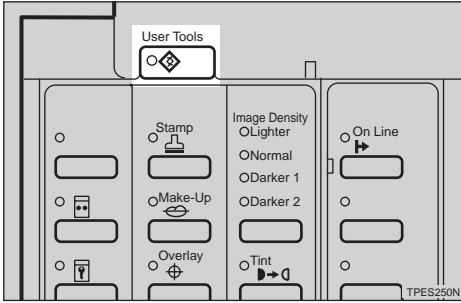

2 Make sure that 1 is selected. Then press the **[OK]** key.

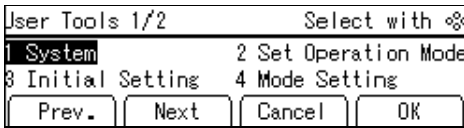

3 Enter 8 with the Number keys. Then press the **[OK]** or **[Enter]** key.

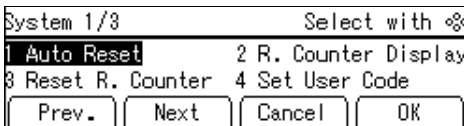

4 Enter the year with the Number keys.

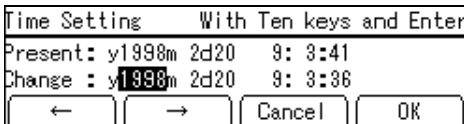

5 Press the **[Enter]** key.

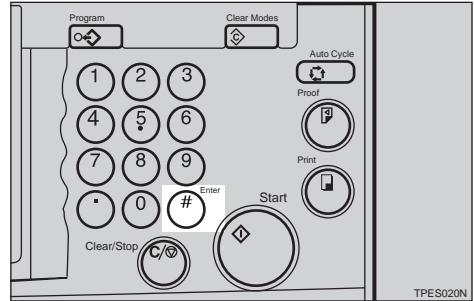

6 Input the month with the Number keys.

7 Press the **[Enter]** key.

Note

- Follow steps **6** and **7** for the "date", "hour", "minute", and "second".

8 Press the **[OK]** key.

3-4 Reproduction Ratio

1 Press the **[User Tools]** key.

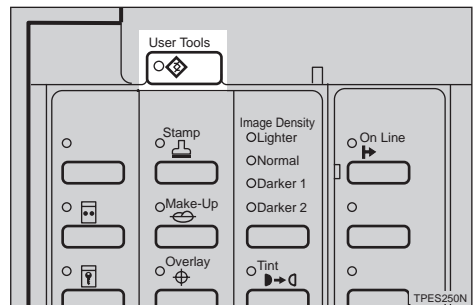

2 Enter 3 with the Number keys. Then press the **[OK]** or **[Enter]** key.

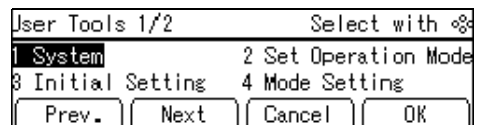

- 3** Enter 4 with the Number keys. Then press the [OK] or [Enter] key.

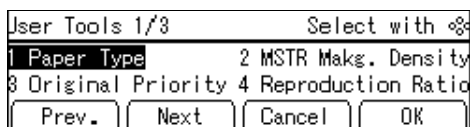

- 4** Select the ratio you want to adjust with the [←], [→], [◀], or [▶] key.

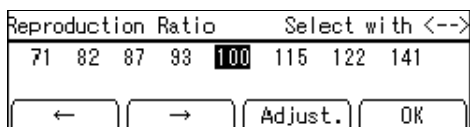

- 5** Press the [Adjust.] key.
- 6** Enter the desired ratio with the [←], [→], [◀], or [▶] key.

Note

- You can also enter the ratio with the Number keys.

- 7** Press the [OK] key twice.

3-5 Class Enter No.

- 1** Press the [User Tools] key.

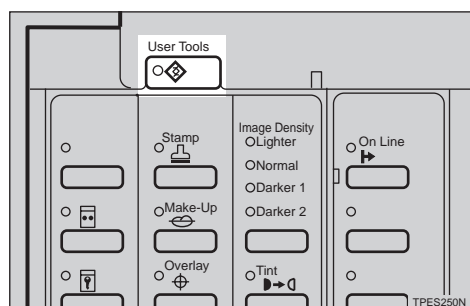

- 2** Enter 3 with the Number keys. Then press the [OK] or [Enter] key.

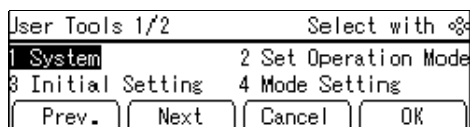

- 3** Enter 5 with the Number keys. Then press the [OK] or [Enter] key.



- 4** Select the grade with the [←], [→], [◀], or [▶] key.

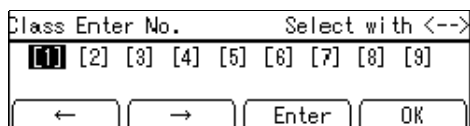

- 5** Press the [Enter] key.
- 6** Select the class with the [←], [→], [◀], or [▶] key.

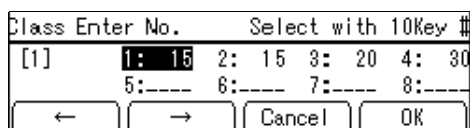

7 Enter the number of students with the Number keys. Then press the [Enter] key.

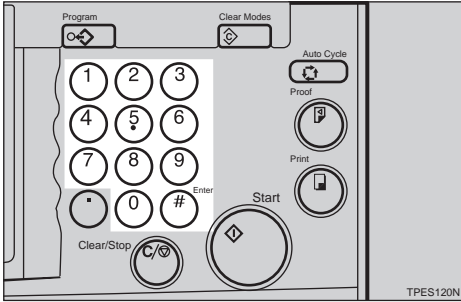

Note

- Repeat steps 6 and 7 until you have finished registering number of students in each class.

8 Press the [OK] key.

Note

- Repeat steps 4 through 8 until you have finished registering number of students in each class for the other grades.

9 Press the [OK] key.

3-9 Margin Erase Area

1 Press the [User Tools] key.

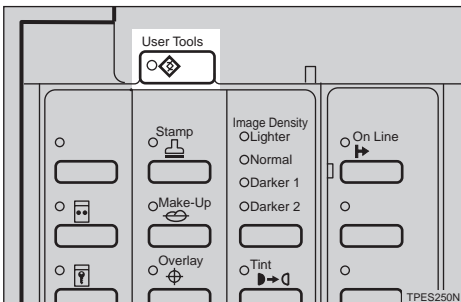

2 Enter 3 with the Number keys. Then press the [OK] or [Enter] key.

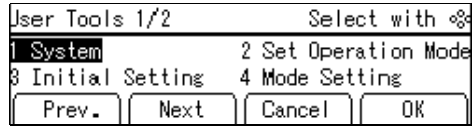

3 Enter 9 with the Number keys. Then press the [OK] or [Enter] key.

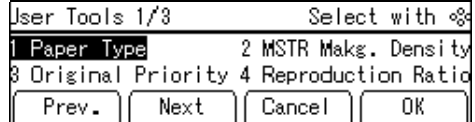

4 Select the original size you will use with the [←], [→], [◀], or [▶] key.

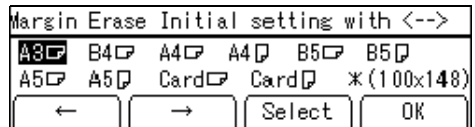

5 Press the [Select] key.

6 Adjust the erase edge margin.

If you selected A3 to A6 or 11" × 17" to 5 1/2" × 8 1/2"

1 Adjust the erase edge margin with the [←], [→], [◀], or [▶] key.

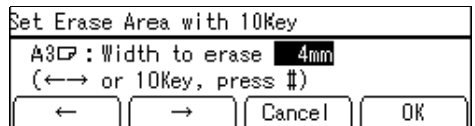

Note

- You can also enter the ratio with the Number keys and the **[Enter]** key.

If you selected *

- 1 Enter the erase edge margin with the Number keys.

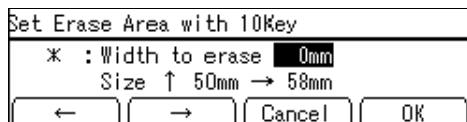

- 2 Press the **[Enter]** key.
- 3 Enter the vertical length of paper you use with the Number keys.
- 4 Press the **[Enter]** key.
- 5 Enter the horizontal width of paper you use with the Number keys.
- 6 Press the **[Enter]** key.

- 7 Press the **[OK]** key twice.

4-11 No. of Skip Feed

The following procedure explains how to change the number of drum rotations.

- 1 Press the **[User Tools]** key.

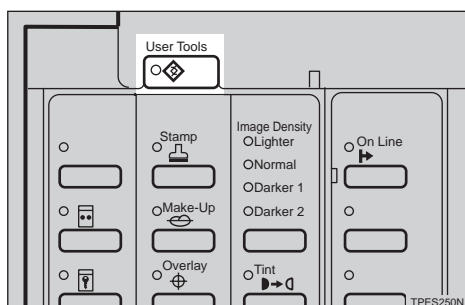

- 2 Enter 4 with the Number keys. Then press the **[OK]** or **[Enter]** key.

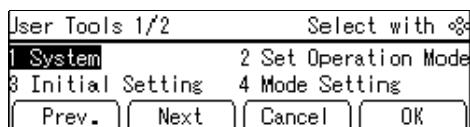

- 3 Enter 11 with the Number keys. Then press the **[OK]** or **[Enter]** key.

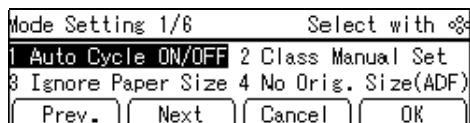

- 4 Press the **[Change]** key.

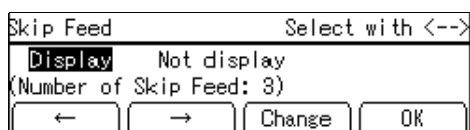

- 5 Change the number of drum rotations while one sheet of paper is fed with the **[←]**, **[→]**, **[◀]**, or **[▶]** key.

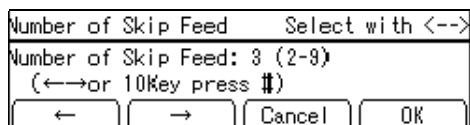
**Note**

- You can also change the number of rotations with the Number keys.

- 6 Press the **[OK]** key.

4-14 No. of Q.start

Note

The default settings are as follows:

		Time period			
		0 – 4 hours	4 – 24 hours	24 – 72 hours	More than 72 hours
Temperature	Low Tmp. (10 – 15°C, 50 – 59°F)	0	15	45	45
	Normal Tmp. (15 – 28°C, 59 – 82.4°F)	0	0	15	15
	High Tmp. (28 – 30°C, 82.4 – 86°F)	0	0	0	15

1 Press the **[User Tools]** key.

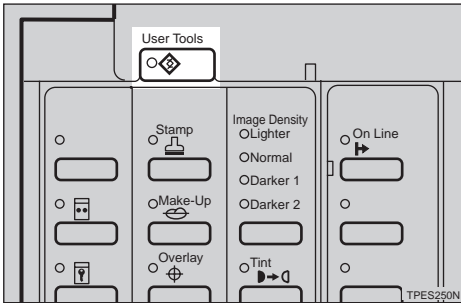

2 Enter 4 with the Number keys. Then press the **[OK]** or **[Enter]** key.

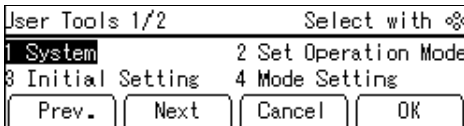

3 Enter 14 with the Number keys. Then press the **[OK]** or **[Enter]** key.

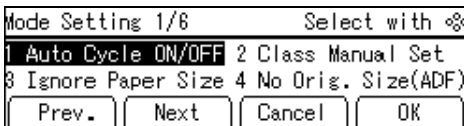

- 4** Select the temperature at which you use this machine with the [←], [→], [◀], or [▶] key.

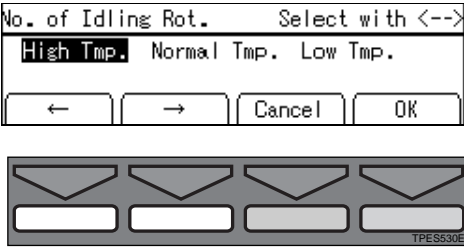

- 5** Press the [OK] key.

- 6** Select the time period you want to change how many times the drum unit idles with the [←], [→], [◀], or [▶] key.

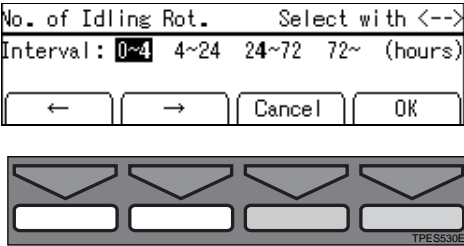

- 7** Press the [OK] key.

- 8** Select the number of drum rotations with the [←], [→], [◀], or [▶] key.

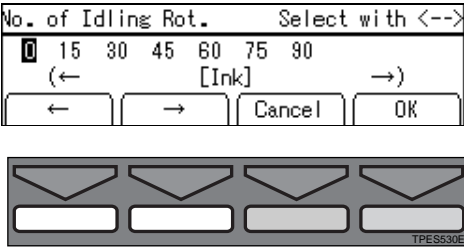

- 9** Press the [OK] key.

4-19 Type of Paper

1 Press the **[User Tools]** key.

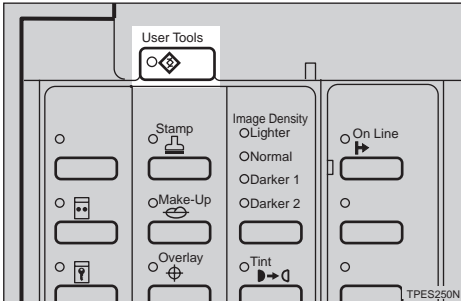

2 Enter 4 with the Number keys. Then press the **[OK]** or **[Enter]** key.

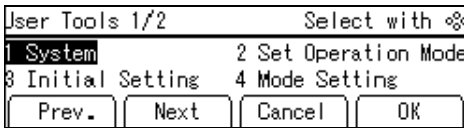

3 Enter 19 with the Number keys. Then press the **[OK]** or **[Enter]** key.

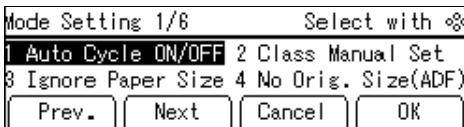

4 Select **[User 1]** or **[User 2]** with the **[←]**, **[→]**, **[◀]**, or **[▶]** key.

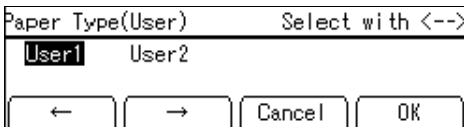

5 Press the **[OK]** key.



6 Select the paper type and misfeed condition with the **[←]** or **[→]** key.

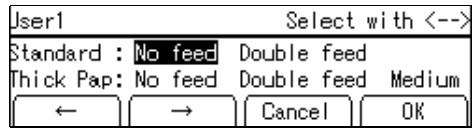

7 Press the **[OK]** key.

8 Press the **[Cancel]** key.

5-4 Stamp Position

Note

The default position and available settings of each stamp are as follows:

Stamp positions	Default	Available settings
<p>GRSP0S0E</p>	<p>a = 24 mm, 0.96"</p> <p>b = 24 mm, 0.96"</p>	<p>a = 8 – 104 mm, 0.32" – 4.16"</p> <p>b = 8 – 144 mm, 0.32" – 5.76"</p>
<p>GRSP0S1E</p>	<p>a = 24 mm, 0.96"</p> <p>b = 0 mm, 0"</p> <p>c = center line</p>	<p>a = 8 – 104 mm, 0.32" – 4.16"</p> <p>b = -72 – 72 mm, -2.88" – 2.88"</p>
<p>GRSP0S2E</p>	<p>a = 24 mm, 0.96"</p> <p>b = 24 mm, 0.96"</p>	<p>a = 8 – 104 mm, 0.32" – 4.16"</p> <p>b = 8 – 144 mm, 0.32" – 5.76"</p>

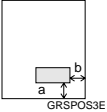
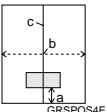
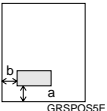
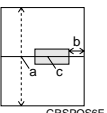
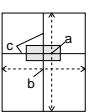
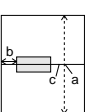
Stamp positions	Default	Available settings
	a = 24 mm, 0.96" b = 24 mm, 0.96"	a = 8 – 104 mm, 0.32" – 4.16" b = 8 – 144 mm, 0.32" – 5.76"
	a = 24 mm, 0.96" b = 0 mm, 0" c = center line	a = 8 – 104 mm, 0.32" – 4.16" b = -72 – 72 mm, -2.88" – -2.88"
	a = 24 mm, 0.96" b = 24 mm, 0.96"	a = 8 – 104 mm, 0.32" – 4.16" b = 8 – 144 mm, 0.32" – 5.76"
	a = 0 mm, 0" b = 24 mm, 0.96" c = center line	a = -52 – 52 mm, -2.08" – -2.08" b = 8 – 144 mm, 0.32" – 5.76"
	a = 0 mm, 0" b = 0 mm, 0" c = center line	a = -52 – 52 mm, -2.08" – -2.08" b = -72 – 72 mm, -2.88" – -2.88"
	a = 0 mm, 0" b = 24 mm, 0.96" c = center line	a = -52 – 52 mm, -2.08" – -2.08" b = 8 – 144 mm, 0.32" – 5.76"

1 Press the **[User Tools]** key.

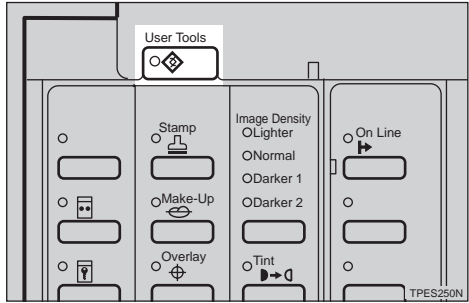

2 Enter 5 with the Number keys. Then press the **[OK]** or **[Enter]** key.

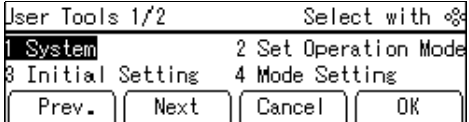

3 Enter 4 with the Number keys. Then press the **[OK]** or **[Enter]** key.

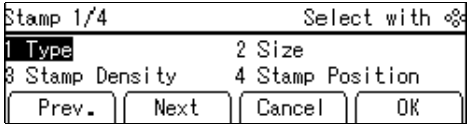

4 Select the stamp position you want to adjust with the **[←]**, **[→]**, **[◀]**, or **[▶]** key.

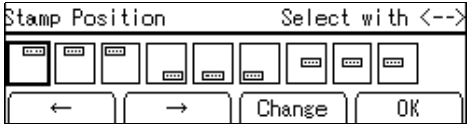

5 Press the **[Change]** key.

6 Adjust the horizontal stamp position with the Number keys.

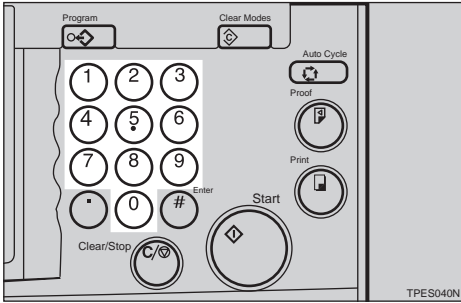

7 Press the [Enter] key.

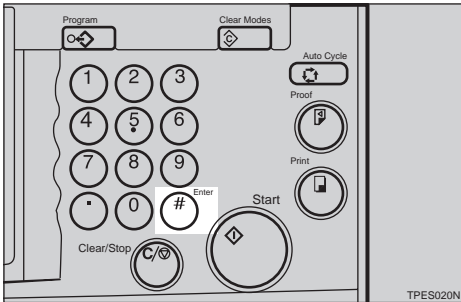

8 Adjust the vertical stamp position with the Number keys.

9 Press the [Enter] key.

10 Press the [OK] key twice.

5-7 Position (User)

Note

The default position and available settings of each user stamp are as follows:

Stamp positions	Default	Available settings
<p>GSPSPOS0E</p>	<p>a = 24 mm, 0.96"</p> <p>b = 24 mm, 0.96"</p>	<p>a = 8 – 104 mm, 0.32" – 4.16"</p> <p>b = 8 – 144 mm, 0.32" – 5.76"</p>

Stamp positions	Default	Available settings
<p>GRSPOS1E</p>	<p>a = 24 mm, 0.96"</p> <p>b = 0 mm, 0"</p> <p>c = center line</p>	<p>a = 8 – 104 mm, 0.32" – 4.16"</p> <p>b = –72 – 72 mm, –2.88" – 2.88"</p>
<p>GRSPOS2E</p>	<p>a = 24 mm, 0.96"</p> <p>b = 24 mm, 0.96"</p>	<p>a = 8 – 104 mm, 0.32" – 4.16"</p> <p>b = 8 – 144 mm, 0.32" – 5.76"</p>
<p>GRSPOS3E</p>	<p>a = 24 mm, 0.96"</p> <p>b = 24 mm, 0.96"</p>	<p>a = 8 – 104 mm, 0.32" – 4.16"</p> <p>b = 8 – 144 mm, 0.32" – 5.76"</p>
<p>GRSPOS4E</p>	<p>a = 24 mm, 0.96"</p> <p>b = 0 mm, 0"</p> <p>c = center line</p>	<p>a = 8 – 104 mm, 0.32" – 4.16"</p> <p>b = –72 – 72 mm, –2.88" – 2.88"</p>
<p>GRSPOS5E</p>	<p>a = 24 mm, 0.96"</p> <p>b = 24 mm, 0.96"</p>	<p>a = 8 – 104 mm, 0.32" – 4.16"</p> <p>b = 8 – 144 mm, 0.32" – 5.76"</p>
<p>GRSPOS6E</p>	<p>a = 0 mm, 0"</p> <p>b = 24 mm, 0.96"</p> <p>c = center line</p>	<p>a = –52 – 52 mm, –2.08" – 2.08"</p> <p>b = 8 – 144 mm, 0.32" – 5.76"</p>

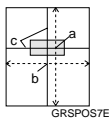
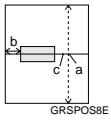
Stamp positions	Default	Available settings
	a = 0 mm, 0" b = 0 mm, 0" c = center line	a = -52 - 52 mm, -2.08" - 2.08" b = -72 - 72 mm, -2.88" - 2.88"
	a = 0 mm, 0" b = 24 mm, 0.96"	a = -52 - 52 mm, -2.08" - 2.08" b = 8 - 144 mm, 0.32" - 5.76"

1 Press the **[User Tools]** key.

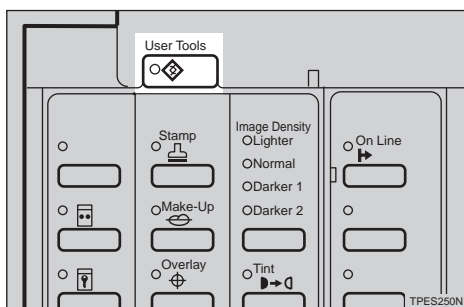

2 Enter 5 with the Number keys. Then press the **[OK]** or **[Enter]** key.

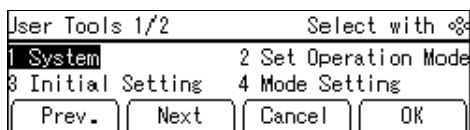

3 Enter 7 with the Number keys. Then press the **[OK]** or **[Enter]** key.

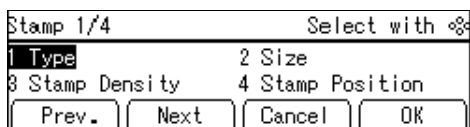

4 Select the user stamp position you want to adjust with the **[←]**, **[→]**, **[◀]**, or **[▶]** key.

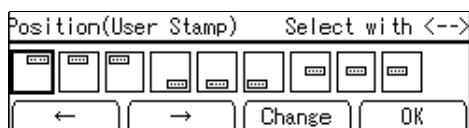

5 Press the **[Change]** key.

6 Adjust the horizontal user stamp position with the Number keys.

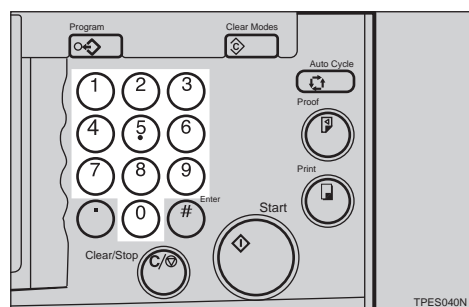

7 Press the **[Enter]** key.

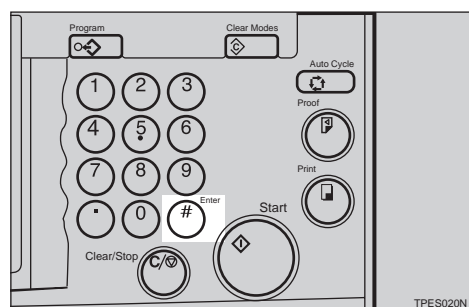

8 Adjust the vertical user stamp position with the Number keys.

9 Press the **[Enter]** key.

10 Press the **[OK]** key twice.

5-8 Regist. (User)

1 Press the **[User Tools]** key.

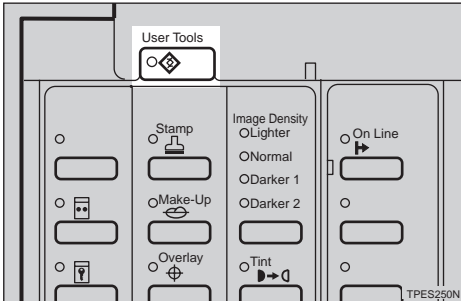

2 Enter 5 with the Number keys. Then press the **[OK]** or **[Enter]** key.

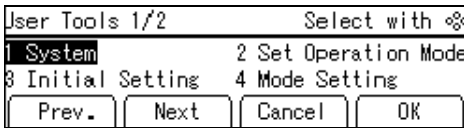

3 Enter 8 with the Number keys. Then press the **[OK]** or **[Enter]** key.

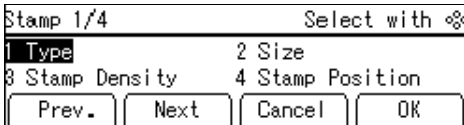

4 Select one of the four available user stamps with the **[←]**, **[→]**, **[<]**, or **[>]** key.

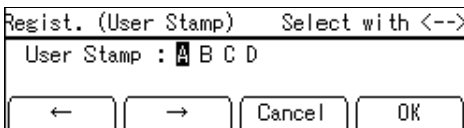

Note

- If the stamp you choose is already being used, the machine asks whether you wish to overwrite it or not. Select the **[Yes]** or **[No]** key.

5 Press the **[OK]** key.

6 Set the original you want to register as a user stamp on the exposure glass (contact glass).

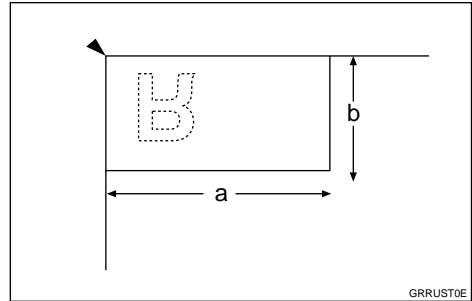

a: 64 mm, 2.5"

b: 32 mm, 1.2"

Note

- The image area as shown in the illustration will be registered as a user stamp.

7 Press the **[Start]** key.

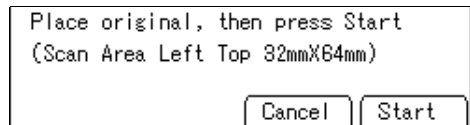

8 Press the **[Cancel]** key.

5-11 Position (Date)

Note

- The default position and available settings of each date stamp are as follows:

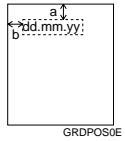
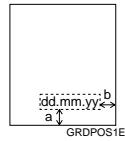
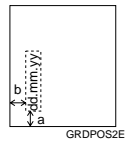
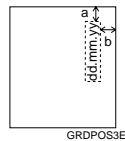
Stamp positions	Default	Available settings
	a = 8 mm, 0.32" b = 20 mm, 0.80"	a = 8 - 40 mm, 0.32" - 1.60" b = 8 - 40 mm, 0.32" - 1.60"
		
	a = 20 mm, 0.80" b = 12 mm, 0.48"	
	a = 20 mm, 0.80" b = 8 mm, 0.32"	

1 Press the **[User Tools]** key.

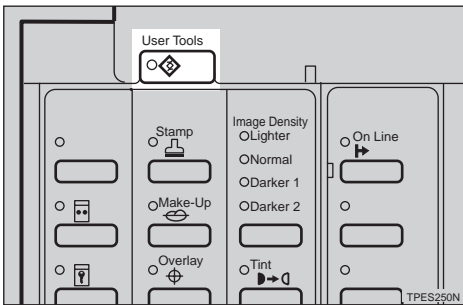

2 Enter 5 with the Number keys. Then press the **[OK]** or **[Enter]** key.

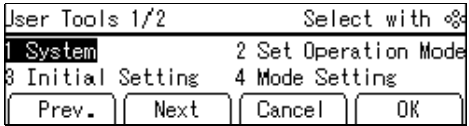

3 Enter 11 with the Number keys. Then press the **[OK]** or **[Enter]** key.

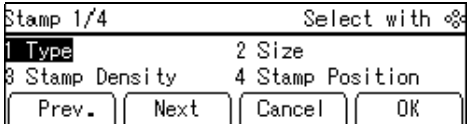

4 Select the date stamping direction you want to adjust with the **[←]**, **[→]**, **[◀]**, or **[▶]** key.

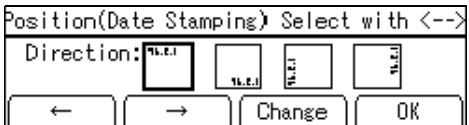

5 Press the **[Change]** key.

6 Adjust the horizontal date stamping position with the Number keys.

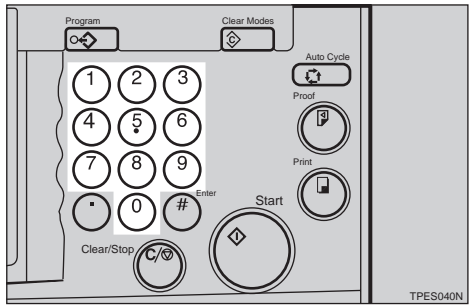

7 Press the **[Enter]** key.

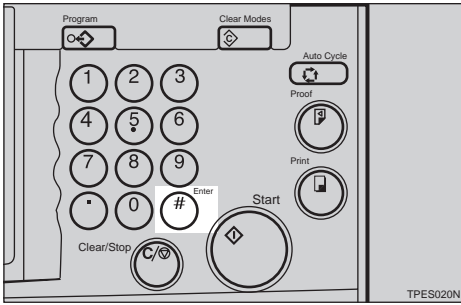

8 Adjust the vertical date stamping position with the Number keys.

9 Press the **[Enter]** key.

10 Press the **[OK]** key twice.

5-14 Position (Page)

Note

The default position and available settings of each page stamp are as follows:

◆ When you select P1 (1/5)

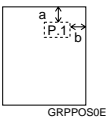
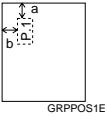
Stamp positions	Default	Available settings
	a = 8 mm, 0.32" b = 12 mm, 0.48"	a = 8 – 40 mm, 0.32" – 1.60" b = 8 – 40 mm, 0.32" – 1.60"
	a = 12 mm, 0.48" b = 12 mm, 0.48"	

◆ When you select -1-

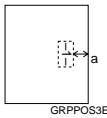
Stamp positions	Default	Available settings
	a = 8 mm, 0.32"	a = 8 – 40 mm, 0.32" – 1.60"
		

1 Press the **[User Tools]** key.

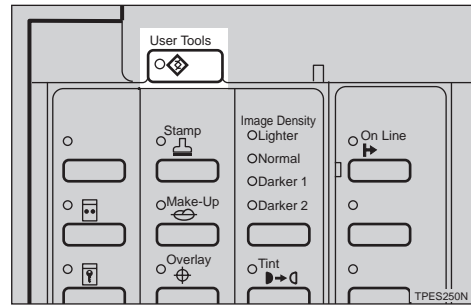

2 Enter 5 with the Number keys. Then press the **[OK]** or **[Enter]** key.

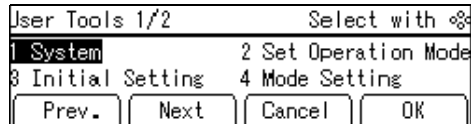

3 Enter 14 with the Number keys. Then press the **[OK]** or **[Enter]** key.

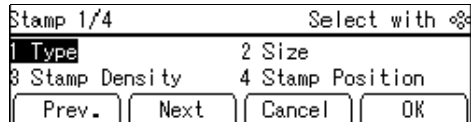

- 4** Select the page numbering direction you want to adjust with the [←], [→], [◀], or [▶] key.

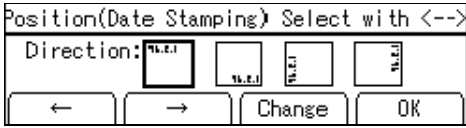

- 5** Press the [Change] key.
- 6** Adjust the horizontal page numbering position with the Number keys.

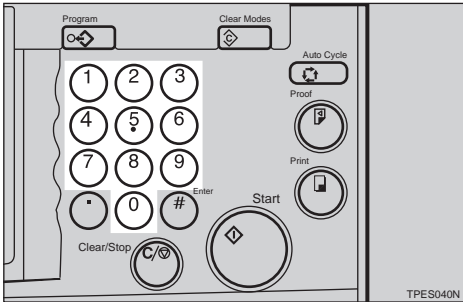

- 7** Press the [Enter] key.

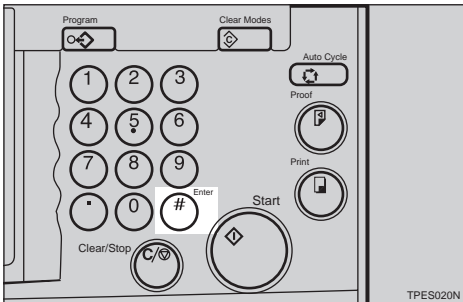

- 8** Adjust the vertical page numbering position with the Number keys.

Note

- You need not follow steps **8** and **9** when you select “-1-” as the direction in step **4**.

- 9** Press the [Enter] key.

- 10** Press the [OK] key twice.

5-15 Make/Chg. Pattern

- 1** Press the [User Tools] key.

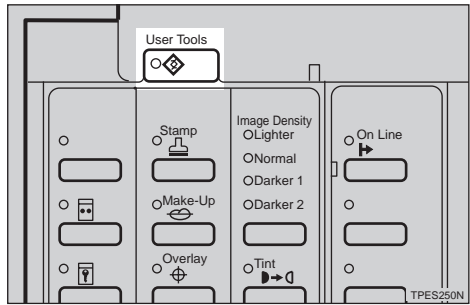

- 2** Enter 5 with the Number keys. Then press the [OK] or [Enter] key.

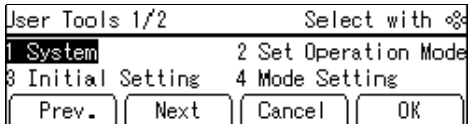

- 3** Enter 15 with the Number keys. Then press the [OK] or [Enter] key.

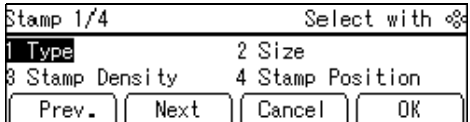

- 4** Select the background pattern with the [◀], [▶], [△], or [▽] key.

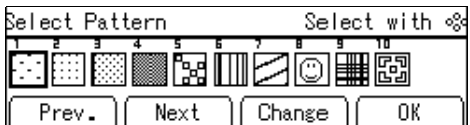

- 5** Press the [Change] key.

- 6** Move the cursor to the position you wish to edit with the [←], [→], [↑], or [↓] key.

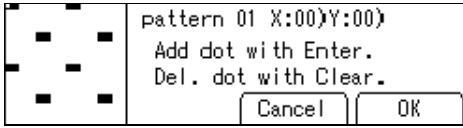

- 7** Press the [Enter] or [Clear/Stop] key to edit the pattern.

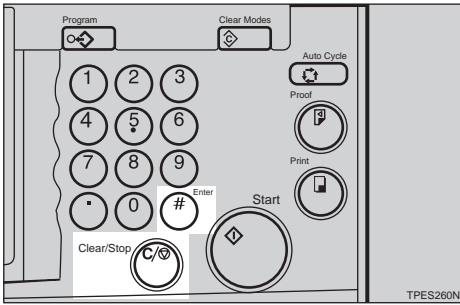

Note

- To add a dot, press the [Enter] key.
- To remove a dot, press the [Clear/Stop] key.
- Repeat steps 6 and 7 until you have finished editing the pattern.

- 8** Press the [OK] key twice.

6-1 Check Counter

- 1** Press the [User Tools] key.

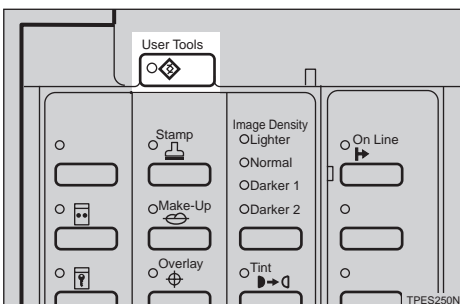

- 2** Enter 6 with the Number keys. Then press the [OK] or [Enter] key.

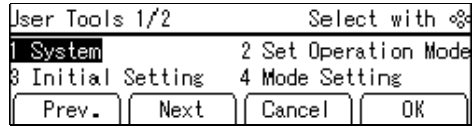

- 3** Make sure that 1 is selected. Then press the [OK] key.

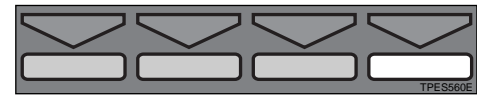
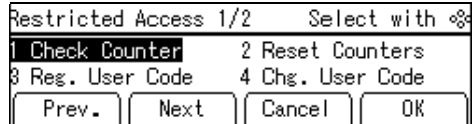

Note

- The number of masters and prints made under the first user code will be displayed in the panel display.

- 4** Keep pressing the [→] or [▷] key to display the number of masters and prints made under your user code.

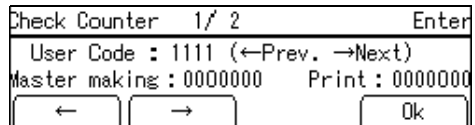

- 5** Press the [OK] key after checking the number of masters and prints made under your user code.

6-2 Reset Counters

- 1 Press the **[User Tools]** key.

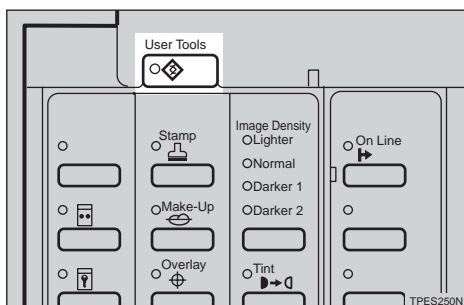

- 2 Enter 6 with the Number keys. Then press the **[OK]** or **[Enter]** key.

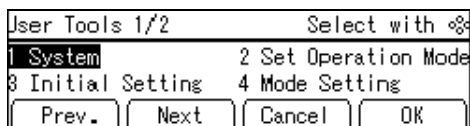

- 3 Enter 2 with the Number keys. Then press the **[OK]** or **[Enter]** key.

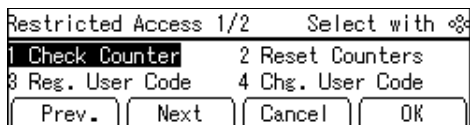

- 4 Select **[Single]** or **[All]** with the **[←]**, **[→]**, **[<]**, or **[>]** key.

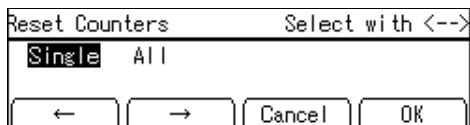

- 5 Press the **[OK]** key.

If you selected **[Single]**

- 1 Keep pressing the **[→]** or **[>]** key to display the number of

masters and prints made under your user code.

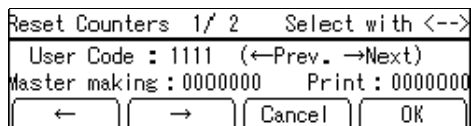

- 2 Press the **[OK]** key.
- 3 Press the **[Yes]** key.
- 4 Press the **[Cancel]** key twice.

If you selected **[All]**

- 1 Press the **[Yes]** key.

6-4 Chg. User Code

- 1 Press the **[User Tools]** key.

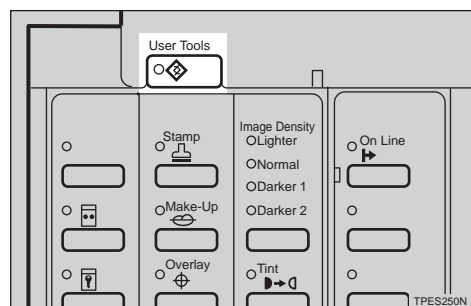

- 2 Enter 6 with the Number keys. Then press the **[OK]** or **[Enter]** key.

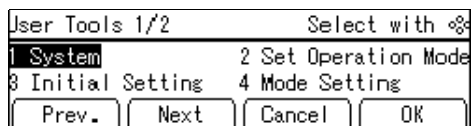

- 3 Enter 4 with the Number keys. Then press the **[OK]** or **[Enter]** key.

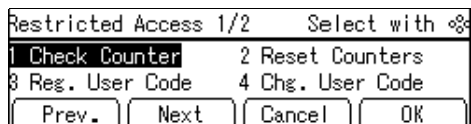

- 4** Keep pressing the [→] or [▷] key to display your user code.

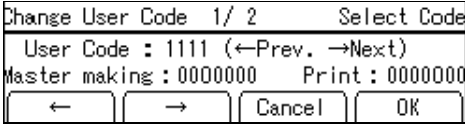

- 2** Enter 6 with the Number keys. Then press the [OK] or [Enter] key.

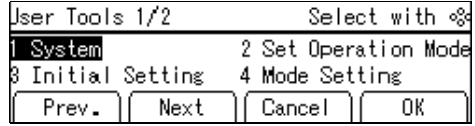

- 3** Enter 5 with the Number keys. Then press the [OK] or [Enter] key.

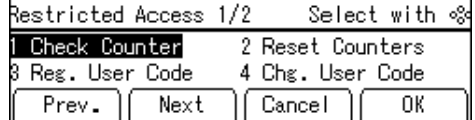

- 4** Keep pressing the [→] or [▷] key to display your user code.

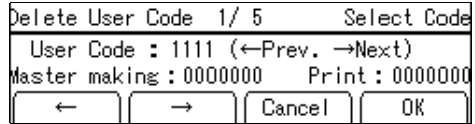

- 5** Press the [OK] key.

- 6** Enter the new user code with the Number keys.

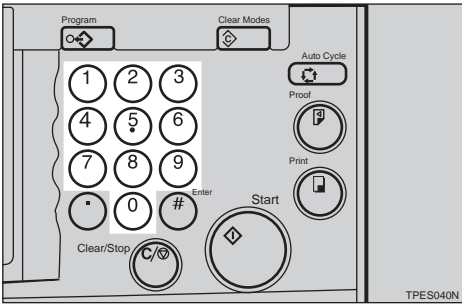

- 7** Press the [OK] key.

6-5 Del. User Code

- 1** Press the [User Tools] key.

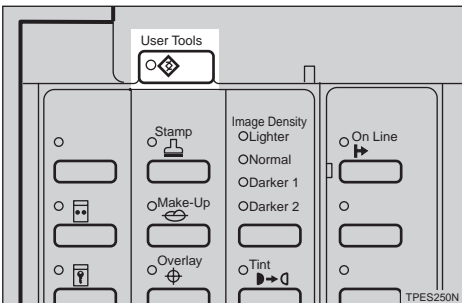

- 5** Press the [OK] key.

- 6** Press the [Yes] key.

4. What To Do If Something Goes Wrong

If Your Machine Does Not Operate As You Want

If a malfunction or a misfeed occurs within the machine, the following messages will appear on the panel display.

Message	Meaning
Drum unit is not set. Set Drum unit.	Make sure that the drum is completely set in position.
Max. quantity: ****	The number of prints exceeds the maximum print quantity. You can change the maximum number of prints that can be made in one operation with the user tools. See "Max. Quantity" in ⇒ P.136 "2. Set Operation Modes".
Min. quantity: ****	The number of prints does not exceed the minimum print quantity. You can change the minimum number of prints that can be made in one operation with the user tools. See "Min. Quantity" in ⇒ P.136 "2. Set Operation Modes".
Set original. Set command sheet.	Make prints after you confirm whether there is an original or a command sheet on the exposure glass (contact glass). Make sure that you have changed the original on the exposure glass (contact glass) before pressing the [Start] key.
Size of original and paper is not same.	Set a paper size that matches the reproduction ratio you have selected and your original. The reproduction ratio selected by Auto Magnification Selection mode is too big or too small.  Note <input type="checkbox"/> You can make prints if you press the [Start] key.

 **When a service call message is displayed in the panel display**

Press the **[Exit]** key. Then turn the main switch off and on. If a service code appears again, contact your service representative.

 **Note**

- If a service code appears on the panel display after you turn the main switch off and on a few times, do not continue turning it on and off. Leave the machine off.
- When you make masters continuously using originals with solid images, SC-03-03 tends to appear on the panel display. In this case, turn off the main switch and wait for a while. Then turn on the main switch.

If You Cannot Make Prints As You Want

Problem	Cause	Action
Misfeeds occur frequently.	Improper paper type is selected with the [Ppr. Type] key.	Select proper paper type. See ⇒ P.42 "Printing On Various Kinds Of Paper".
When you try to set several functions at a time, you cannot set some functions.	Some functions cannot be used together.	See ⇒ P.198 "Combination Chart".
Parts of the image are not printed in Edge Erase mode.	Erase margin is too wide.	Set a narrower erase margin with the user tools. See ⇒ P.150 "3-9 Margin Erase Area".
	Edge margins of original are too narrow.	
Prints are blank or parts of the image are not printed.	The paper feed side/end plates are not set correctly.	Make sure that the paper feed side/end plates touch the paper lightly.

4

Combine Originals Mode

Problem	Cause	Action
Prints are blank or parts of the image are not printed.	Original size and direction are not correct.	You cannot use originals of different sizes and directions in Combine Originals mode. Use originals of same size and direction.
Print image is not correct.	Original set order is not correct.	Set originals face up into the optional document feeder. The first original should be on the top.
		Set original face down on the exposure glass (contact glass). The first original should be set first.

Clearing Misfeeds

⚠ CAUTION:



- Be careful not to cut yourself on any sharp edges when you reach inside the machine to remove misfed sheets of paper or masters.

📌 Note

- ❑ After clearing the misfeeds, make sure that all the doors, covers, and units are closed and the ⚠ indicator is off.
- ❑ To prevent misfeeds, do not leave any torn scraps of paper, originals, or masters in the machine.
- ❑ When clearing misfeeds, do not turn off the main switch. If you do your print settings will be cleared.
- ❑ If misfeeds occur repeatedly, contact your service representative.

- Did you select appropriate paper type with the [Ppr. Type] key?

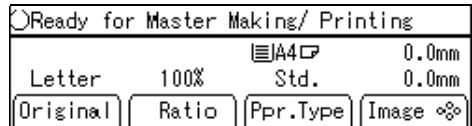

- Are the side plate pads in the correct positions?

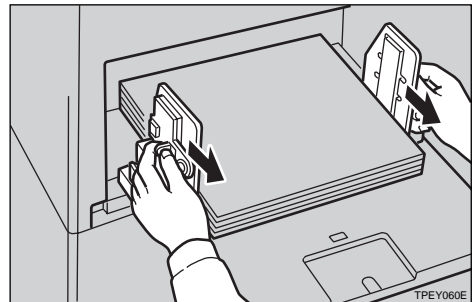

⚠ + A Paper Misfeed In The Paper Feed Section

- 1 Remove the misfed paper.

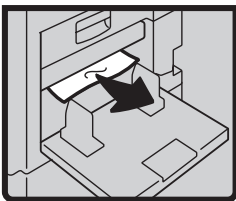

To print on thin paper (47.1 g/m², 12.5 lb), slide the levers (behind the paper feed side/end plates) in the direction of the arrow (see illustration).

- When paper is curled, correct the curl as shown.

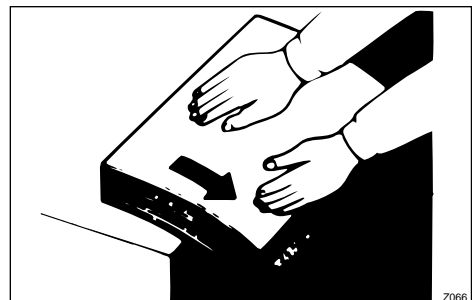

💡 To prevent paper misfeeds:

Check the following before restarting the printing run.

- When paper edges stick together or paper is not fed to the machine, shuffle the paper as shown.

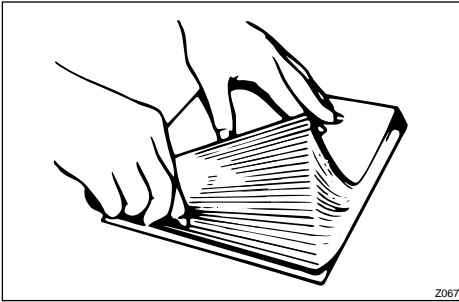

- When you use postcards or thick paper, lower the printing speed to setting 1 or 2. See ⇒ P.28 "Changing The Printing Speed".

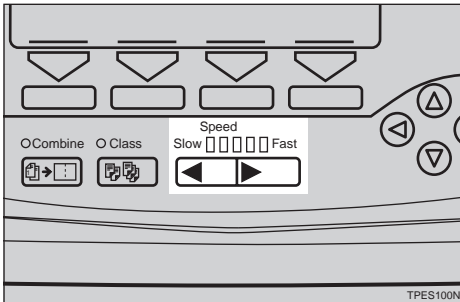

- When a multi-feed occurs or the paper is skewed, make sure that the paper feed side/end plates are properly adjusted. When you load paper on the paper feed tray, make sure that the paper edge touches the back fence and paper is placed on the proper paper size scale. Only use paper where the leading edge has two right angle corners.

"A + B" Paper Misfeed In The Paper Feed Section

- 1 Open the front door.

- 2 Lower drum unit lock lever B1.

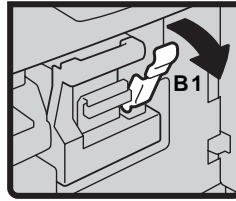

- 3 Take out the drum.

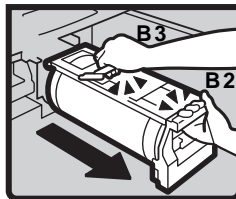
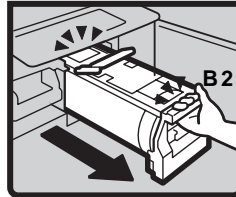

Note

- For how to take out the drum unit, see ⇒ P.87 "Changing The Color Drum Unit".

- 4 Pull out the misfed paper gently from the inside.

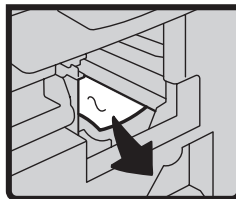

- 5 If you cannot remove the misfed paper, remove paper from the paper feed tray.

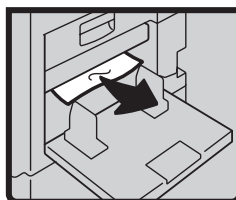

- 6 Set the drum unit and close the front door.

To prevent paper misfeeds:

See ⇒ P.168 ““x + A” Paper Misfeed In The Paper Feed Section”.

“8 + B” Paper Or Master Wrapped Around The Drum

When The Master Is Wrapped Around The Drum

- 1 Open the front door.
- 2 Lower drum unit lock lever B1.

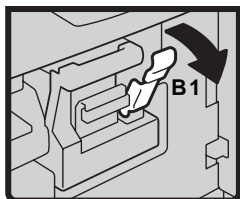

- 3 Take out the drum.

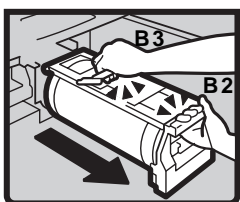
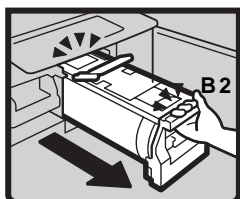

Note

- For how to take out the drum unit, see ⇒ P.87 “Changing The Color Drum Unit”.

- 4 While pressing the drum lock, grasp the edge of the master (the white area) and peel it off.

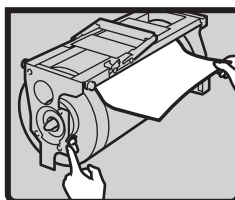

- 5 Return the drum lock to its original position.

- 6 Set the drum unit and close the front door.

When Paper Is Wrapped Around The Drum

- 1 Open the front cover.
- 2 Lower drum unit lock lever B1.

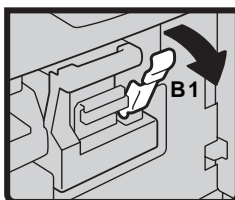

3 Take out the drum.

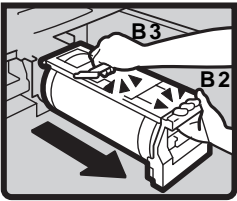
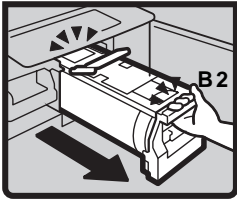

Note

- For how to take out the drum unit, see ⇒ P.87 “Changing The Color Drum Unit”.

4 Remove the misfed paper from the drum.

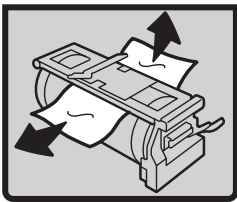

5 If you cannot find misfed paper in step 4, remove misfed paper from the pressure cylinder.

6 Set the drum unit and close the front door.

When Paper Is Misfed Inside The Machine

1 Open the front cover.

2 Lower drum unit lock lever B1.

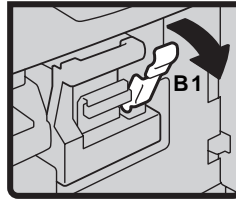

3 Take out the drum.

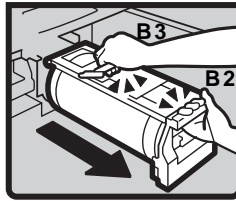
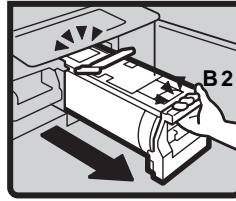

Note

- For how to take out the drum unit, see ⇒ P.87 “Changing The Color Drum Unit”.

4 Remove the misfed paper from the inside as shown in the illustration.

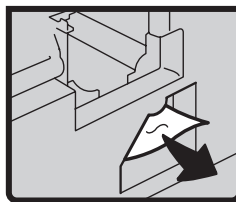

5 If you cannot remove the misfed paper, remove paper from the pressure cylinder.

6 Set the drum unit and close the front door.

To prevent paper misfeeds:

If the paper is curled or the original's leading edge margin is too narrow, the following action is necessary.

- When you use curled paper, correct the curl as shown.



- If you cannot correct the paper curl, stack the paper with the curl face down as shown.

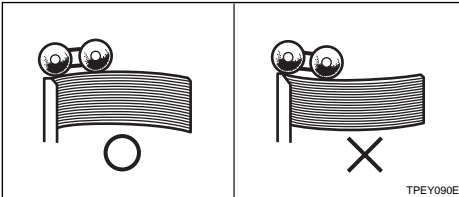

- When the leading edge margin of the original is less than 10 mm, 0.4" or there is a solid image on the leading edge, insert the original with the widest margin first or make a leading edge margin by making a copy.

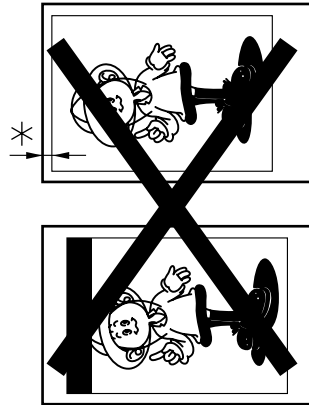

* = Less than 10 mm, 0.4"

"R + C" Paper Misfeed In The Paper Exit Section

- 1 Slowly but firmly pull out the misfed paper.

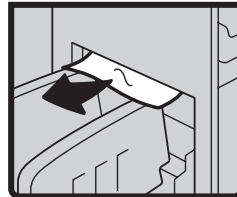

To prevent paper misfeeds:

When a thin paper misfeed in the paper exit section occurs, reduce the printing speed with the **[Speed]** keys. (See ⇒ P.28 "Changing The Printing Speed".) If you cannot reduce the printing speed, close the trailing edge guides or move the end plate toward the paper delivery tray edge.

"R + D" Master Misfeed In The Master Feed Section

- 1** Pull out the master feed unit until it stops.
- 2** Open the master guide.

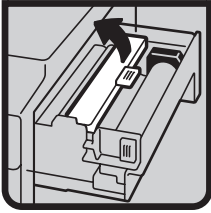

- 3** Open the master feed unit cover (1).
- 4** Remove the master roll (2).

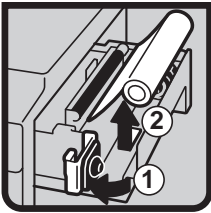

- 5** Reset the master roll (1).

Note

- The master roll must be positioned as shown in the illustration in step 6.

- 6** Close the master feed unit cover (2).

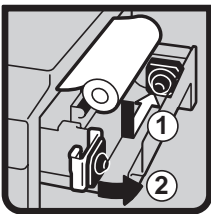

- 7** Insert the paper edge of the master roll as shown in the illustra-

tion until the master edge reaches the arrow mark.

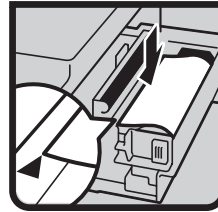

- 8** Close the master guide.

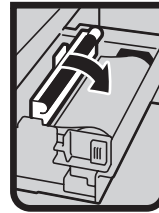

- 9** Push in the master feed unit until it stops.

"R + D + B" Master Misfeed In The Master Feed Section

- 1** Open the front door.
- 2** Lower drum unit look lever B1.

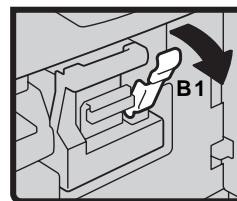

3 Take out the drum.

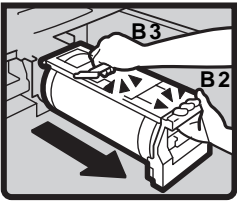
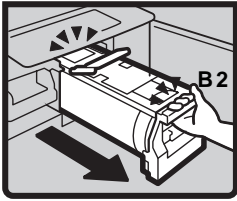

3 Take out the drum.

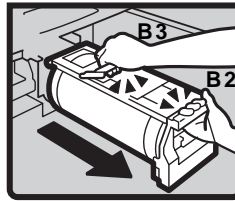
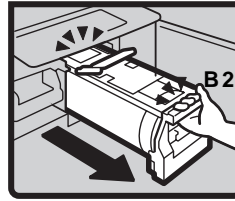

4

4 Pull out the misfed master from the inside.

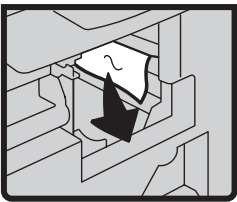

Note

For how to take out the drum unit, see ⇒ P.87 "Changing The Color Drum Unit".

4 If you find a misfed master on the drum unit, grasp the edge of the master (the white area) and peel it off while pressing the drum lock.

5 Set the drum unit and close the front door.

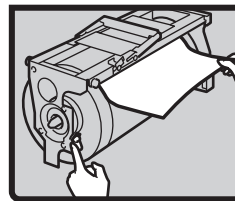

"8 + B + E" Master Misfeed in The Master Eject Section

1 Open the front door.

2 Lower drum unit lock lever B1.

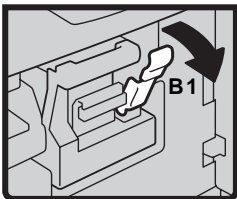

5 Return the drum lock to its original position.

6 Grasp handle E1 and pull out the master eject unit until it stops.

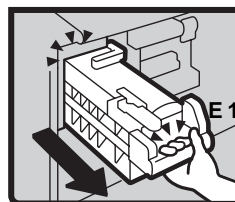

- 7** Pull out lever E3 and remove the misfed master.

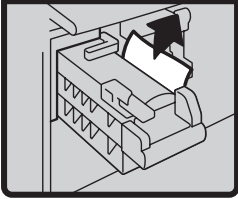
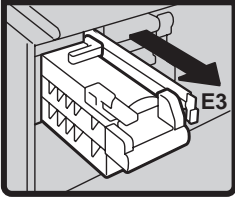

- 8** Return lever E3 and the master eject unit to their original position.

- 9** Set the drum unit and close the front door.

"P" + E" Master Misfeed In The Master Eject Section

- 1** Open the front door.
2 Grasp handle E1 and pull out the master eject unit until it stops.

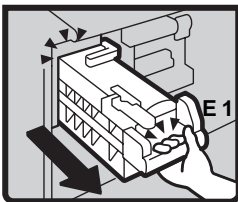

- 3** Check where the misfed master is. Remove the misfed master.

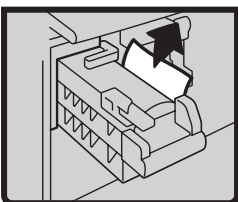

- 4** Return the master eject unit to its original position and close the front door.

"P" + P" Original Misfeed Occurs When Using The Optional Document Feeder

- 1** Open the ADF cover.

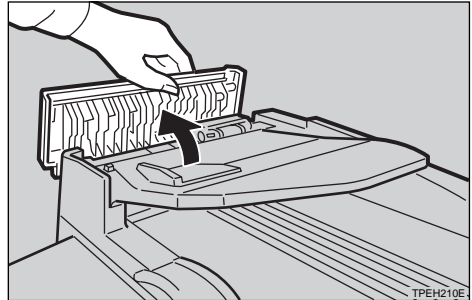

- 2** Pull out the misfed original gently.

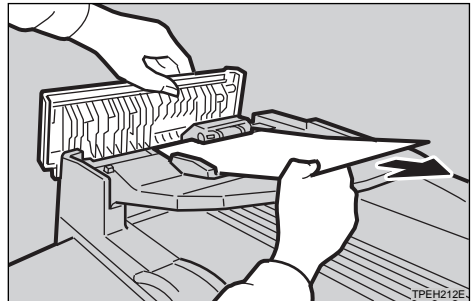

- 3** If you cannot remove misfed original in step 2, open the document feeder.

4 Pull the green knob towards you and remove the misfed original.

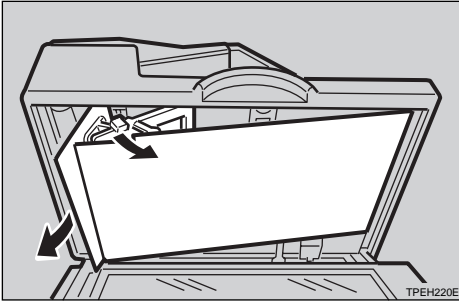

5 Return the document feed sheet to its original position.

6 Close the ADF cover until it clicks in position and if necessary, close the document feeder.

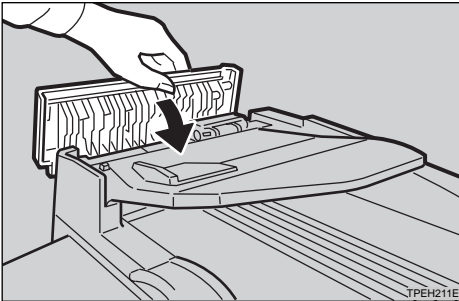

- Curled, folded, or creased originals
- Originals with any kind of coating, such as thermal fax paper, art paper, aluminum foil, carbon paper, or conductive paper
- Bound originals such as books
- Damaged originals
- Originals with glue on them
- Pasted originals
- Originals written in pencil
- Thin originals that have low stiffness
- Originals with index tabs
- Translucent paper

Note

- Do not mix different sizes of originals in the optional document feeder.
- Remove staples or clips of originals. Fan originals that have had staples or clip removed.
- Do not stack originals above the limit mark.

To prevent original misfeeds:

Set the following kinds of originals on the exposure glass (contact glass).

- Originals heavier than 105 g/m², 27 lb
- Originals lighter than 52 g/m², 14 lb
- Originals smaller than 105 mm × 128 mm, 4.2" × 5.1"
- Originals larger than 297 mm × 864 mm, 11.6" × 33.8"
- Stapled or clipped originals
- Perforated or torn originals

When The Open Cover/Unit Indicator () Lights

 Make sure that the following door/cover are closed.

❖ Front Door

Close the front door completely.

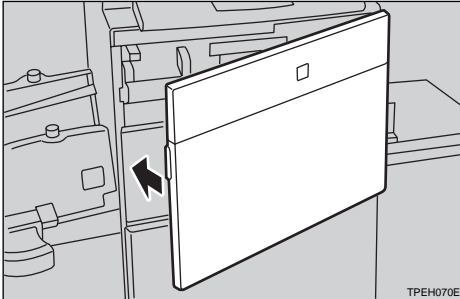

❖ Document Feeder Cover (Option)

Close the document feeder cover until it locks in position.

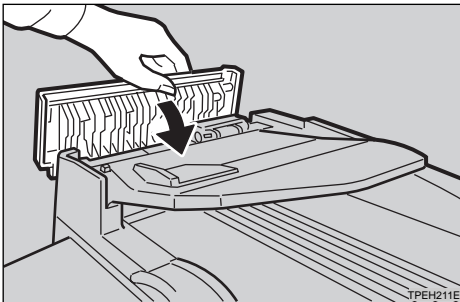

When The Add Ink Indicator (🖨️) Lights

The Add Ink indicator (🖨️) lights when it is time to supply ink.

⚠️ CAUTION:



- If ink comes into contact with your eyes, rinse immediately in running water. In the case of any abnormal symptoms, consult a doctor.

⚠️ CAUTION:



- Keep the ink or ink container out of reach of children.

⚠️ CAUTION:



- If ink is ingested, force vomiting by drinking a strong saline solution and consult a doctor immediately.

⚠️ CAUTION:



- This machine has been tested for safety using this supplier's parts and consumables. We recommend you only use these specified supplies.

📌 Note

- Ink is readily removed from skin by waterless hand cleaners followed by washing with soap and water.
- Be careful not to get any ink on your clothing.
- Store ink under low temperature and humidity conditions.
- Do not store ink where it will be exposed to heat or direct sunlight.
- Store on a flat surface.

1 Open the front door.

2 Pull out the ink holder.

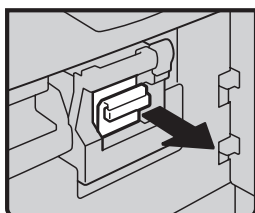

- 3** Remove the used ink cartridge.

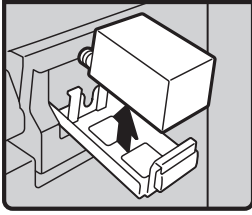

- 4** Remove the cap of the new ink cartridge.

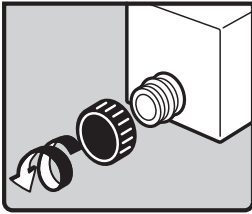

- 5** Insert the new cartridge into the ink holder.

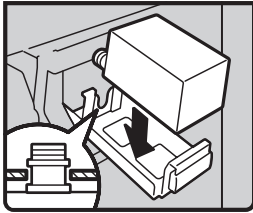

 **Note**

- Always supply ink of the same color.

- 6** Return the ink holder to its original position until it clicks.

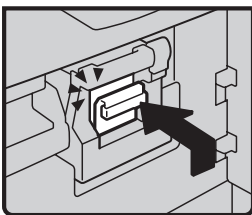

- 7** Close the front door.

The machine will start idling to supply ink to the drum.

When The Master End Indicator (📏) Lights

The Master End indicator (📏) lights when it is time to replace the master roll or when you need to set the master roll.

⚠ CAUTION:



• This machine has been tested for safety using this supplier's parts and consumables. We recommend you only use these specified supplies.

1 Pull out the master feed unit until it stops.

2 Open the master guide.



3 Open the master feed unit cover (1).

4 Remove the used master roll (2).

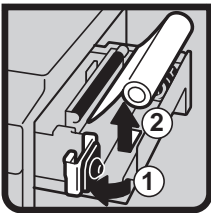

📌 Note

When the Master End indicator is lit, it is necessary to replace the master roll even if some master remains on the old roll.

5 The new master roll must be positioned as shown in the illustration (1).

6 Close the master feed unit cover (2).

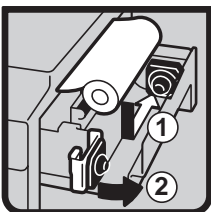

4

- 7** Insert the paper edge of the master roll as shown in the illustration until the master edge reaches the arrow mark.

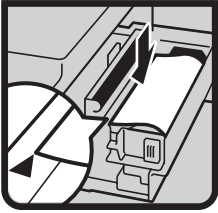

- 8** Close the master guide.

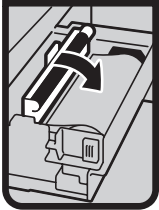

- 9** Push in the master feed unit until it stops.

When The Master Eject Indicator (🔌) Lights

The Master Eject indicator (🔌) lights when it is time to empty the master eject unit or when you need to set the master eject unit.

Note

- ❑ Ink is readily removed from skin by waterless hand cleaners followed by washing with soap and water.
- ❑ Be careful not to get any ink on your clothing while emptying the master eject unit.

- 1** Prepare the trash box.
- 2** Open the front door.
- 3** Grasp handle E1 and pull out the master eject unit until it stops.

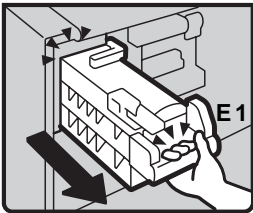

- 4** Pull up handle E2 and pull out the master eject unit completely.

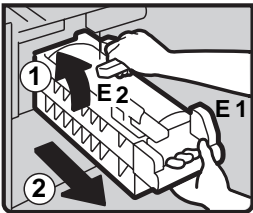

- 5** Grasp the master eject unit upper handle and turn it clockwise with one hand while holding handle E1 with other hand (1).

- 6** Remove the used master by pushing down the master eject unit upper handle towards the trash box (2).

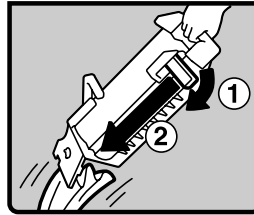







Note

- ❑ If you cannot remove the used masters completely, repeat step **6** until all the masters are removed.

- 7** Reinstall the master eject unit until it clicks in position.
- 8** Close the front cover.

When Other Indicators Are Lit

Indicator	Meaning and action
 <p>TPES270E</p>	The key counter (option) is not set. Insert the key counter.
<ul style="list-style-type: none"> • (Metric version)  • (Inch version)  	Color drum unit is installed.
<ul style="list-style-type: none"> • (Metric version)  • (Inch version)  	A3/11" × 17" drum unit is set.
<ul style="list-style-type: none"> • (Metric version)  • (Inch version)  	A4/8 ¹ / ₂ " × 11" drum unit is set.

When The Prints Are Not Delivered In A Neat Stack

If you use small size paper, prints might not be delivered in a neat stack. In this case, follow the steps below.

- 1** Lower the end plate a little. While holding the end plate, lift the angle adjustment screw.



- 2** Adjust the end plate angle by turning the screw clockwise or counterclockwise.

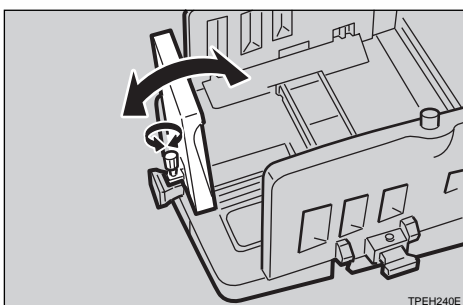

Poor Printing

Dirty Background

If the background of prints is dirty, the drum unit is dirty.

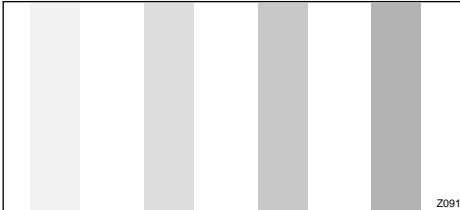

⚠ CAUTION:



- If ink comes into contact with your eyes, rinse immediately in running water. In the case of any abnormal symptoms, consult a doctor.

⚠ CAUTION:



- Keep the ink or ink container out of reach of children.

⚠ CAUTION:



- If ink is ingested, force vomiting by drinking a strong saline solution and consult a doctor immediately.

Note

- When you use paper smaller than the original image, select the proper reduction ratio. Otherwise, you might get dirty background prints.
- When you use postcards and the like, the background might be dirty because postcards do not absorb ink well. In this case, lower the printing speed or use Skip Feed mode to dry the ink on the prints.

1 Turn off the main switch.

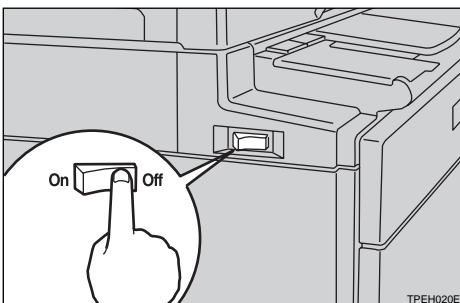

2 Pull out the drum unit.

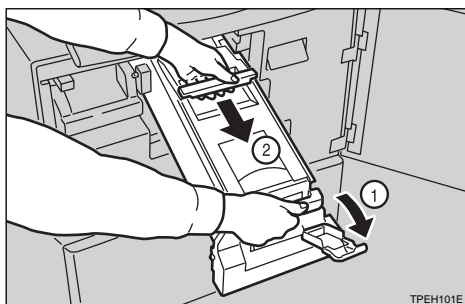

Note

□ For how to take out the drum unit, see ⇒ P.87 “Changing The Color Drum Unit”.

3 While pressing the drum lock, turn the drum until you can see the trailing edge of the master.

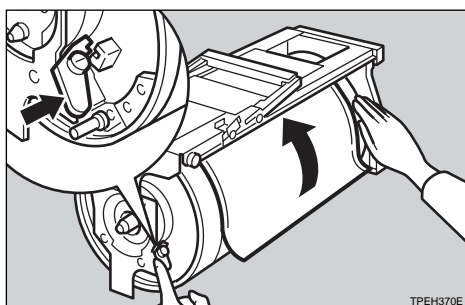

4 With a dry soft cloth, remove any ink that has accumulated on the trailing edge of the drum unit.

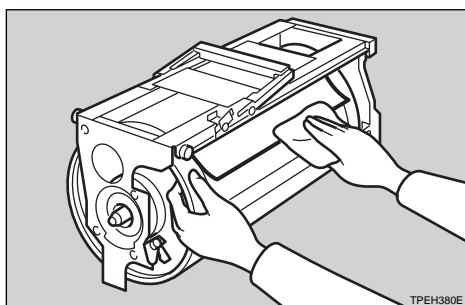

Important

□ Do not use benzine, thinner, or other organic liquids. Otherwise, this machine might be damaged.

- 5** Insert the drum unit until it locks in position, then lower the drum unit lock lever.

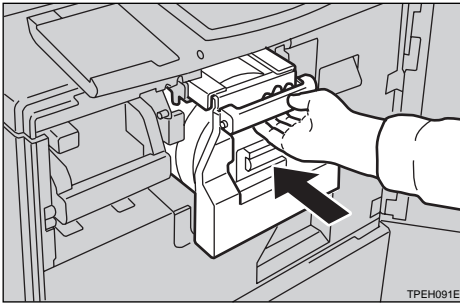

- 6** Close the front door.

- 7** Turn on the main switch.

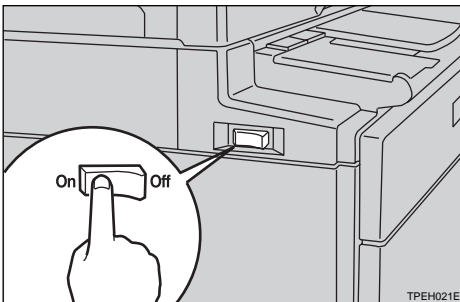

Black Line/Stain

Check the platen cover and clean it if dirty. See ⇒ P.196 “Platen Cover”.

Check the exposure glass (contact glass) and clean it if dirty. See ⇒ P.196 “Exposure glass (contact glass)”.

Check the sheet of the optional document feeder and clean it if dirty. See ⇒ P.197 “Sheet”.

 **Note**

- When black lines or stains still appear on prints even if you clean the above, contact your service representative.

 **Reference**

See ⇒ P.87 “Changing The Color Drum Unit”.

- 2** While pressing the drum lock, grasp the edge of the master (white part of the master) and peel it off.

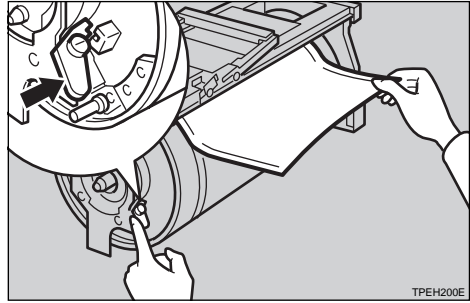

- 3** Return the drum lock to its original position.

- 4** Set the drum unit until it clicks in position and close the front cover.

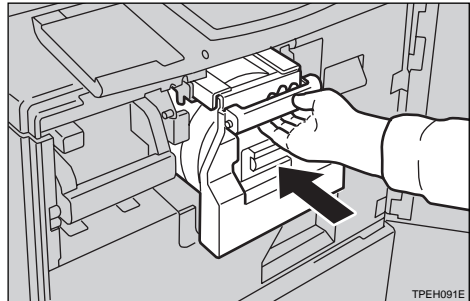

Skipped Prints

If the machine is not used for a long period of time or you change the color drum unit, the ink on the drum might dry causing print quality to deteriorate. To solve this problem, use Quality Start Mode. See ⇒ P.76 “Quality Start Mode—Regaining The Image Density When The Ink On The Drum Dries”.

When you get skipped print images even if you use Quality Start mode, perform the following procedure.

- 1** Open the front cover and pull out the drum unit.

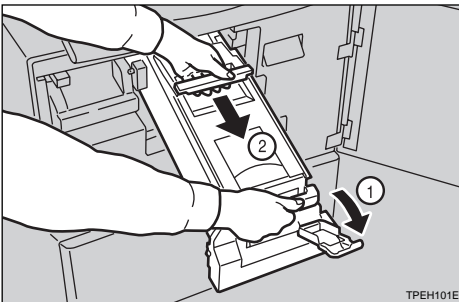

Operation Notes

General Cautions

- While printing, do not turn off the main switch.
- While printing, do not open the door or covers.
- While printing, do not unplug the power cord.
- While printing, do not move the machine.
- Keep corrosive liquids, such as acid, off the machine.
- Open and close the door and covers softly.
- Do not put anything except originals or command sheets on the machine.
- When opening or closing the door or covers, keep hold of them so they don't fall.
- Always turn the machine off when you have finished printing for the day.
- If the machine must be transported by vehicle, please contact your service representative.
- Make sure to make a few trial prints to check the image position because the image position of the trial print might not correspond with that of the original.
- If the image registration is not consistent, slow the printing speed down to setting 1 or 2.
- When performing duplex or multicolored printing, leave the printed paper for a while before the next printing in order to let the ink dry on the printed paper. If this is not done, feed roller marks will appear on the print image.
- When the machine is used in low temperature conditions, the image density might decrease. In this case, slow the printing speed down to setting 1 or 2.
- When making duplex prints, misdetection of paper wrapping might occur if the paper delivery sensor detects a black area at the leading edge of the back side. Keep at least an 10 mm, 0.4" margin at the leading edge of the back side of the printing paper.
- Press the **【Proof】** key to perform a test print as the first few prints might be light.
- When making duplex prints or when using non-white printing paper, the paper size detection sensors might malfunction and some part of the image might not appear on the print. In this case, place a blank sheet under the printing paper on the paper feed tray.

- When making duplex prints or when using non-white printing paper, the paper end sensor might malfunction and fail to detect the paper. In this case, place a blank sheet under the printing paper on the paper feed tray.
- The outer portion of the image might not be printed under low temperature. In this case, slow the printing speed down to setting 1 or 2, or increase the room temperature.
- The paper exit pawl might contact the printing paper and cause black lines on the prints. In this case, increase the printing speed or make a new master with lighter image density mode.
- The leading edge of the prints might become stained if the edge touches the image of prints on the paper delivery tray.
- The ink of the print on the paper delivery tray might stick to the back side of the next print.
- When the machine is on and the power source is less than 90 % of the specified amount, printing quality will decrease. Therefore, make sure the supply from your electrical outlet is at least 90 % of the required amount.
- As various kinds and qualities of paper exist, some paper might be wrapped around the drum or cause misfeeds.
- If your hands are stained with ink:
 - Avoid prolonged or repeated contact with skin.
 - Cleanse skin thoroughly after contact, before breaks and meals, and at the end of the work period.
 - Ink is readily removed from skin by waterless hand cleaners followed by washing with soap and water.
- Also, be careful not to get any ink on your clothing while emptying the master eject unit or while loading a new ink cartridge.
- The image density varies according to the printing speed and the room temperature. So, adjust the printing speed or increase the room temperature.
- When you make a lot of prints from a small image, ink might ooze out from the edges of the master, especially under high temperature and when printing in two or more colors. In this case, make a new master.
- Use ink made within one year. Ink stored for a long period tends to dry slowly and yield lower image density.
- While making a master, do not leave the platen cover or optional document feeder open.
- When you store 1,000 ml/pack ink, make sure to store it upright with the cap pointing up.
- If you use originals of letters in Light or Dark Tone function, edges of the letters might be printed clearly and inside of the letters might become screened image.

- When you use originals with light lettering, edges of the letters might be printed clearly and the inside of the letters might be light. In this case, increase the image density.
- When you use originals of fine letters, letters on prints might be skipped. In this case, increase the image density or use Letter mode.
- Up to 1,000 sheets of paper can be delivered to the paper delivery tray. However, if 500 or more sheets of paper are delivered to the paper delivery tray, the leading edge of the prints might become stained.
- When you use envelope or pasted print paper, the leading edge of print might be damaged.
- When the machine is used in low temperature conditions, the printing area might become small.

Print Paper

- When you use non-standard paper, some parts of the image might not appear on the print. In this case, set the machine not to detect paper size with the user tools. See "Ignore Paper Size" in ⇒ P.139 "4. Mode Setting".
- When the paper is curled, stack the paper with the curl face down, otherwise the paper might wrap around the drum or stains might appear.
- Postcards and the like do not absorb ink well. Offset images might appear on the rear side of subsequent prints. Solid image originals will cause offset image prints.

Originals

- If there is no margin or if there is a solid image area near the leading edge of the original, make at least a 10 mm, 0.4", margin at the leading edge; otherwise, the paper might wrap around the drum or the paper exit pawl might become dirty and cause black lines on prints.
- If you use originals that have bold letters or solid images at the leading edges, you might get prints with dirty edges. In this case, insert the widest margin first, or raise the printing speed.

Misfed Paper

- When printing a large solid area on A3, 11" × 17" paper, the sides of the print tend to curl up after the print is fed out to the paper delivery tray. The next sheet that feeds out pushes against the curled sheet and a paper misfeed occurs. In this case, slow the printing speed down (setting 1 or 2).

PC Controller

Important

- Make sure that  indicator on the PC controller operation panel is off before unplugging the power cord.

Where To Put Your Machine

Your machine's location should be carefully chosen because environmental conditions greatly affect its performance.

Environmental Conditions

Optimum environmental conditions

WARNING:



- *Do not put any metal objects or containers holding water (e.g. vases, flowerpots, glasses) on the machine. If the contents fall inside the machine, a fire or electric shock could occur.*

CAUTION:



- *Keep the machine away from humidity and dust. A fire or an electric shock might occur.*
- *Do not place the machine on an unstable or tilted surface. If it topples over, it could cause injury.*

CAUTION:



- *If you use the machine in a confined space, make sure there is a continuous air turnover.*

CAUTION:



- *After you move the machine, fix it with the caster fixture. Otherwise, the machine might move or come down to cause a personal injury.*

- Temperature: 10 – 30°C, 50 – 86°F
- Humidity: 20 – 90 % RH
- A strong and level base (a sturdy desk and cabinet etc.).
- The machine must be level within 5 mm, $\frac{13}{64}$ " both front to rear and left to right.
- Be sure to locate this machine in a large well ventilated room that has an air turnover of more than 30 m³/hr/person.

Environments to avoid

- Locations exposed to direct sunlight or strong light (more than 1500 lux).

- Locations directly exposed to cool air from an air conditioner or heated air from a heater. (Sudden temperature changes might cause condensation within the machine.)
- Places where the machine might be subjected to frequent strong vibration.
- Dusty areas.
- Areas with corrosive gases.

Power connection

WARNING:



- **Only connect the machine to the power source described on the inside front cover of this manual.**
- **Avoid multi-wiring.**
- **Do not damage, break or make any modifications to the power cord. Do not place heavy objects on it, pull it hard or bend it more than necessary. These actions could cause an electric shock or fire.**
- **Do not plug or unplug the power cord with your hands wet. Otherwise, an electric shock might occur.**

WARNING:



- **Make sure the wall outlet is near the machine and freely accessible so that in event of an emergency it can be unplugged easily.**

CAUTION:



- **When you move the machine, unplug the power cord from the wall outlet to avoid fire or electric shock.**
- **When the machine will not be used for a long time, unplug the power cord.**

CAUTION:

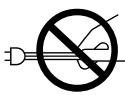

- **When you pull out the plug from the socket, grip the plug to avoid damaging the cord and causing fire or electric shock.**

Make sure the plug is firmly inserted in the outlet.

Access to machine

Place the machine near the power source, providing clearance as shown.

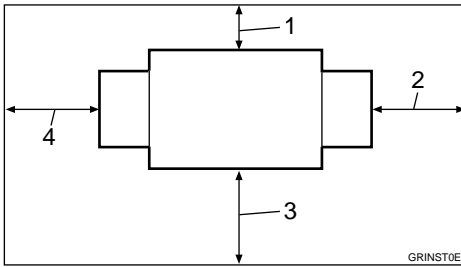
◆ Main Frame

- 1. More than 10 cm, 4.0"**
- 2. More than 60 cm, 23.7"**
- 3. More than 60 cm, 23.7"**
- 4. More than 60 cm, 23.7"**

Maintaining Your Machine

To maintain high print quality, clean the following parts and units regularly.

Important

- Do not use benzine, thinner, or other organic liquids. Otherwise, this machine might be damaged.

Main Frame

Exposure glass (contact glass)

5

- 1** Lift the platen cover or document feeder.

- 2** Clean the exposure glass (contact glass) with a damp cloth and wipe it with a dry cloth.

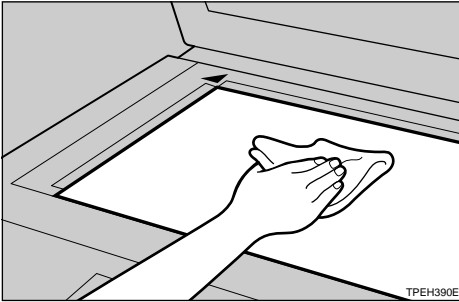

Note

- If you do not clean the exposure glass (contact glass), marks on the glass will be printed.

Platen Cover

- 1** Lift the platen cover.

- 2** Clean the platen cover with a damp cloth and wipe it with a dry cloth.

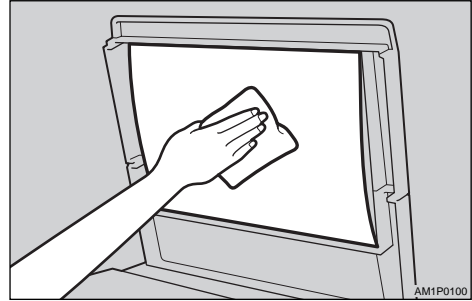

Note

- If you do not clean the platen cover, marks on the cover will be printed.

Paper feed roller (paper feed tray)

- 1** Wipe off the paper dust on the paper feed roller with a damp cloth, then wipe it with a dry cloth.

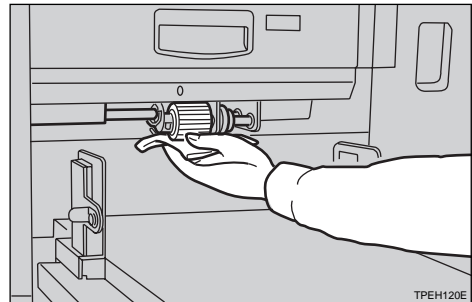

Note

- If you do not clean the paper feed roller, paper misfeeds tend to occur.

Optional Document Feeder

Sheet

- 1** Lift the document feeder.
- 2** Clean the sheet with a damp cloth and wipe it with a dry cloth.

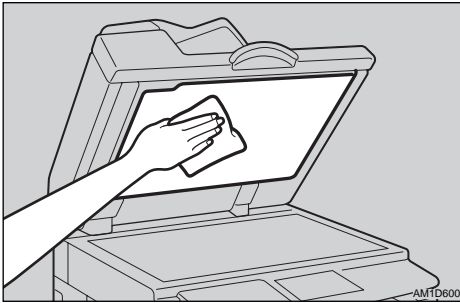

 **Note**

- If you do not clean the sheet, marks on the sheet will be printed.

		Function to be specified later																												
		Letter, Photo, Letter/Photo, Pencil mode	Economy mode	Tint mode	Auto Cycle	Preset Reduce/Enlarge, Zoom	Auto Magnification Selection	Directional Magnification (%)	Directional Magnification (size)	Combine Originals (2 Images on one sheet)	Combine Originals (4 Images on one sheet)	Memory Combine mode (4 Originals)	Memory Combine mode (8 Originals)	Memory Combine mode (16 Originals)	Edge Erase	All Class mode	Auto Class mode	Manual Class mode	Class mode	Job Separation	Overlay	Form	Stamping Date	Page Stamping	Stamping mode	User Stamping	Repeat	Make-up	Skip Feed	On Line
Function specified earlier	Memory Combine mode (4 Originals)	☆	☆	☆	☆	☆	☆	☆	☆	☆	☆	☆	☆	☆	☆	☆	☆	☆	☆	☆	☆	☆	☆	☆	☆	☆	☆	☆	☆	☆
	Memory Combine mode (8 Originals)	☆	☆	☆	☆	☆	☆	☆	☆	☆	☆	☆	☆	☆	☆	☆	☆	☆	☆	☆	☆	☆	☆	☆	☆	☆	☆	☆	☆	☆
	Memory Combine mode (16 Originals)	☆	☆	☆	☆	☆	☆	☆	☆	☆	☆	☆	☆	☆	☆	☆	☆	☆	☆	☆	☆	☆	☆	☆	☆	☆	☆	☆	☆	☆
	Edge Erase	☆	☆	☆	☆	☆	☆	☆	☆	☆	☆	☆	☆	☆	☆	☆	☆	☆	☆	☆	☆	☆	☆	☆	☆	☆	☆	☆	☆	☆
	All Class mode	☆	☆	☆	☆	☆	☆	☆	☆	☆	☆	☆	☆	☆	☆	☆	☆	☆	☆	☆	☆	☆	☆	☆	☆	☆	☆	☆	☆	☆
	Auto Class mode	☆	☆	☆	☆	☆	☆	☆	☆	☆	☆	☆	☆	☆	☆	☆	☆	☆	☆	☆	☆	☆	☆	☆	☆	☆	☆	☆	☆	☆
	Manual Class mode	☆	☆	☆	☆	☆	☆	☆	☆	☆	☆	☆	☆	☆	☆	☆	☆	☆	☆	☆	☆	☆	☆	☆	☆	☆	☆	☆	☆	☆
	Class mode	☆	☆	☆	☆	☆	☆	☆	☆	☆	☆	☆	☆	☆	☆	☆	☆	☆	☆	☆	☆	☆	☆	☆	☆	☆	☆	☆	☆	☆
	Job Separation	☆	☆	☆	☆	☆	☆	☆	☆	☆	☆	☆	☆	☆	☆	☆	☆	☆	☆	☆	☆	☆	☆	☆	☆	☆	☆	☆	☆	☆
	Overlay	☆	☆	☆	☆	☆	☆	☆	☆	☆	☆	☆	☆	☆	☆	☆	☆	☆	☆	☆	☆	☆	☆	☆	☆	☆	☆	☆	☆	☆
	Form	☆	☆	☆	☆	☆	☆	☆	☆	☆	☆	☆	☆	☆	☆	☆	☆	☆	☆	☆	☆	☆	☆	☆	☆	☆	☆	☆	☆	☆
	Stamping Date	☆	☆	☆	☆	☆	☆	☆	☆	☆	☆	☆	☆	☆	☆	☆	☆	☆	☆	☆	☆	☆	☆	☆	☆	☆	☆	☆	☆	☆
	Page Stamping	☆	☆	☆	☆	☆	☆	☆	☆	☆	☆	☆	☆	☆	☆	☆	☆	☆	☆	☆	☆	☆	☆	☆	☆	☆	☆	☆	☆	☆
	Stamping mode	☆	☆	☆	☆	☆	☆	☆	☆	☆	☆	☆	☆	☆	☆	☆	☆	☆	☆	☆	☆	☆	☆	☆	☆	☆	☆	☆	☆	☆
	User Stamping	☆	☆	☆	☆	☆	☆	☆	☆	☆	☆	☆	☆	☆	☆	☆	☆	☆	☆	☆	☆	☆	☆	☆	☆	☆	☆	☆	☆	☆
	Repeat	☆	☆	☆	☆	☆	☆	☆	☆	☆	☆	☆	☆	☆	☆	☆	☆	☆	☆	☆	☆	☆	☆	☆	☆	☆	☆	☆	☆	☆
	Make-up	*2	☆	*2	☆	☆	☆	☆	☆	☆	☆	☆	☆	☆	☆	☆	☆	☆	☆	☆	☆	☆	☆	☆	☆	☆	☆	☆	☆	☆
	Skip Feed	☆	☆	☆	☆	☆	☆	☆	☆	☆	☆	☆	☆	☆	☆	☆	☆	☆	☆	☆	☆	☆	☆	☆	☆	☆	☆	☆	☆	☆
	On Line	*2	☆	*2	☆	*2	*2	*2	*2	*2	*2	*2	*2	*2	*2	*2	*2	*2	*2	*2	*2	*2	*2	*2	*2	*2	*2	*2	*2	*2
	Image Rotation	☆	☆	☆	☆	☆	☆	☆	☆	☆	☆	☆	☆	☆	☆	☆	☆	☆	☆	☆	☆	☆	☆	☆	☆	☆	☆	☆	☆	☆
Master Saving	☆	☆	☆	☆	☆	☆	☆	☆	☆	☆	☆	☆	☆	☆	☆	☆	☆	☆	☆	☆	☆	☆	☆	☆	☆	☆	☆	☆	☆	

This page is intentionally blank.

6. SPECIFICATIONS

Main Frame

❖ **Configuration:**

Desk top

❖ **Printing Process:**

Full automatic one drum system

❖ **Original Type:**

Sheet/Book

❖ **Original Size:**

Maximum 304.8 mm × 432 mm, 12.0" × 17.0"

❖ **Pixel Density:**

400 dpi

❖ **Image Mode:**

Photo mode (Sand pattern)

Letter mode (Standard mode)

Letter/Photo mode

Pencil mode

Tint mode

❖ **Reduction Ratios:**

- Inch version:
93 %, 77 %, 74 %, 65 %
- Metric version:
93 %, 87 %, 82 %, 71 %

❖ **Enlargement Ratios:**

- Inch version:
155 %, 129 %, 121 %
- Metric version:
141 %, 122 %, 115 %

❖ **Zoom:**

From 50 % to 200 % in 1 % steps

❖ **Directional Magnification:**

- Vertical:
From 50 % to 200 % in 1 % steps
- Horizontal:

From 50 % to 200 % in 1 % steps

❖ **Printing Area:**

- A3 drum:
 - Inch version: More than 290 × 419 mm, 11.4" × 16.4"
 - Metric version: More than 290 mm × 409 mm, 11.4" × 16.1"
- A4 drum:
 - More than 290 mm × 200 mm, 11.4" × 7.8"

❖ **Print Paper Size:**

Maximum 297 mm × 432 mm, 11.6" × 17.0"
 Minimum 70 mm × 148 mm, 2.8" × 5.9"

❖ **Leading Edge Margin:**

Less than 10 mm, 0.4"



❖ **Print Paper Weight:**

47.1 g/m² to 209.3 g/m², 12.5 lb to 55.6 lb

❖ **Print Speed:**

60 – 120 rpm (5 steps)

❖ **First Copy Time (Master Process Time):**

Less than 15.5 seconds (A3, 11" × 17" )
 Less than 12 seconds (A4, 8 1/2" × 11" )

❖ **Second Copy Time (First Print Time):**

Less than 18.5 seconds (A3, 11" × 17")
 Less than 15 seconds (A4, 8 1/2" × 11")

❖ **Color Printing:**

Drum unit replacement system (red, blue, green, and brown)

❖ **Image Position:**

- Vertical:
 - Inch version: ± 10 mm, ± 0.4"
 - Metric version: ± 15 mm, ± 0.6"
- Side:
 - ± 10 mm, ± 0.4" (for either side)

❖ **Paper Feed Tray Capacity:**

1,000 sheets (80 g/m², 20 lb)

❖ **Paper Delivery Tray Capacity:**

1,000 sheets (80 g/m², 20 lb)

❖ **Master Eject Unit Capacity:**

- A3 drum
More than 60 masters
- A4 drum
90 masters

❖ **Dimensions (W × D × H):**

	Width	Depth	Height
Stored	625 mm, 24.6"	650 mm, 25.6"	575 mm, 22"
Stored with document feeder	625 mm, 24.6"	650 mm, 25.6"	684 mm, 26.9"
Set up	1,405 mm, 55.4"	650 mm, 25.6"	575 mm, 22"
Set up with cabinet	1,405 mm, 55.4"	650 mm, 25.6"	1,010 mm, 39.8"
Set up with cabinet and document feeder (when you use A4, 8 ¹ / ₂ " × 11" or smaller paper)	1,215 mm, 47.8"	650 mm, 25.6"	1,120 mm, 44.1"
Set up with cabinet and document feeder (when you use B4, 8 ¹ / ₂ " × 14" or larger paper)	1,405 mm, 55.4"	650 mm, 25.6"	1,120 mm, 44.1"

❖ **Weight:**

- Machine:
Less than 94 kg, 207 lb

❖ **Noise Emission:**

Sound pressure level: The measurement are to be made according to ISO 7779 at operator position.

Printing Speed	
60 rpm	57 dB
90 rpm	60 dB
120 rpm	64 dB

❖ **Noise Emission:**

Sound power level: The measurements are made according to ISO 7779.

Printing Speed	
60 rpm	71 dB
90 rpm	74 dB
120 rpm	77 dB

❖ **Power Source:**

See the inside front cover of this manual.

❖ **Power Consumption:**

- Master Making:
Less than 0.3 kW
- Printing:
Less than 0.28 kW

❖ **Optional Equipment:**

- Drum unit: Color Drums
(A3, 11" × 17") - red, blue, green, and brown
(A4, 8¹/₂" × 11") - black, red, blue, green, and brown
- Key Counter
- Cabinet
- Document Feeder
- Memory Board
- PC Controller

Document Feeder

❖ **Original Type:**

Sheet

❖ **Original Weight:**

40.7 g/m² to 127.9 g/m², 10.8 lb to 34 lb

❖ **Original Size:**

Max. 297 mm × 864 mm, 11.6" × 33.8"

Min. 105 mm × 128 mm, 4.2" × 5.1"

❖ **First Copy Time (Master Process Time):**

Less than 19.5 seconds (A3, 11" × 17")

Less than 16 seconds (A4, 8¹/₂ × 11")

❖ **Second Copy Time (First Print Time):**

Less than 22.5 seconds (A3, 11" × 17")

Less than 19 seconds (A4, 8¹/₂ × 11")

❖ **Original Capacity:**

30 sheets (80 g/m², 20 lb)

4.5 mm, 0.17" height

Consumables

Name	Size	Remarks
Master:	Length: 110 m, 410 ft/roll Width: 420 mm, 16.5" 2 Rolls/case	A3 drum More than 200 masters can be made per roll A4 drum 330 masters can be made per roll
Ink-Black	1,000 ml/pack, 600 ml/pack, 5 packs/case	Environmental conditions: -5 to 40°C 10 – 95 % RH
Ink-Red	1,000 ml/pack, 5 packs/case	
Ink-Blue	1,000 ml/pack, 5 packs/case	
Ink-Green	1,000 ml/pack, 5 packs/case	
Ink-Brown	1,000 ml/pack, 5 packs/case	

6

Note

Specifications are subject to change without notice.

INDEX

- 16 One-sided Originals → 1 One-sided Print Of 16 Images, 124
- 1 One-sided Originals → 1 One-sided Print Of 2 Images, 68
- 1 One-sided Originals → 1 One-sided Print Of 4 Images, 68
- 2 One-sided Originals → 1 One-sided Print Of 2 Images, 63
- 2 One-sided Originals → 1 One-sided Print Of 4 Images, 63
- 4 One-sided Originals → 1 One-sided Print Of 4 Images, 124
- 8 One-sided Originals → 1 One-sided Print Of 8 Images, 124

Symbols

- [◀][▶][△], 7
- ☒ Clearing Misfeeds, 168

A

- A3/11" × 17" Drum indicator, 8
- A3/11" × 17" drum unit, 183
- A4/81/2" × 11" Drum indicator, 8
- A4/81/2" × 11" drum unit, 183
- Accessing The User Tools, 133
- Access to machine, 194
- Add Ink Indicator (☒), 178
- Adjusting Print Image Density, 26
- Adjusting Print Image Position, 25
- All Class Mode, 51
- Auto Class Mode, 53
- Auto Combine Mode, 68
- Auto Cycle, 49
- 【Auto Cycle】** key, 7
- Auto Cycle ON/OFF, 139
- Auto Magnification Selection, 32
- Auto Online, 136
- Auto Quality Start, 76
- Auto Reset, 135
- Auto Rotation, 143
- Auto Separate, 142

B

- Background ON/OFF, 140
- Background Patterns, 96
- Black Line/Stain, 188

C

- Cancel, 9
- Cancel Comb., 141
- Caution, iii
- Changing The Paper Size, 23
- Changing The Printing Speed, 28
- Check Counter, 146, 162
- Chg. User Code, 147, 163
- Class Enter No., 138, 149
- 【Class】** key, 7
- Class Manual Set, 139
- Class Mode, 61
- 【Clear Modes】** key, 7
- 【Clear/Stop】** key, 7
- closed area method, 102
- Color Drum, 87, 183
- Color Drum indicator, 8
- Color Printing, 87
- Combination Chart, 198
- Combine, 140
- 【Combine】** key, 6
- Combine Originals, 63
- Combine Originals Printing With The Document Feeder, 83
- Combining Originals Into One Print, 63
- Combining Originals Into One Print With The Memory Board, 124
- Comb. Sep. Line, 140
- Command sheet, 98
- Contact Glass, 3
- Copy Count Display, 137
- Counter, 8

D

- Data Print, 136
- Date Position Set, 145
- Date Style Set, 145
- Deflector Angle, 142
- Del. User Code, 147, 164
- Density (User), 145
- diagonal line method, 101
- Directional Magnification, 37
- Direction (Page), 146
- Dirty Background, 185
- Display Panel Layout, 10
- Drum Size, 90
- Drum Unit, 3
- Drum Unit Lock Lever B1, 3

E

Economy Mode, 48
【**Economy Mode**】key, 6
Edge Erase, 40
【**Edge Erase**】key, 6
【**Enter**】key, 7
Envelopes, 43
Environmental Conditions, 193
Erasing Edge Margins, 40
Exit, 9
Exposure Glass, 3

F

Flip-up Cover, 1
Form, 113
Front Door, 1

H

Halftone Printing, 27
Having Images Repeated On One Print, 68
Having Page Numbers Stamped On Your Prints, 117
Having The Date Stamped On Your Prints, 115
Having The Machine Choose The Reproduction Ratios, 32

I

Idling for Q.start, 141
Ignore Paper Size, 139
【**Image Density**】key, 6
Image Overlay, 113
Image Rotation, 91
Indicators, 8
Initial Setting, 137
Ink, 178
Ink Holder, 3
Ink/Master Left, 143

J

Job Separation, 77
【**Job Separator**】key, 6

K

key counter, 183
Key Operator Code, 147
Keys, 6

L

Language on LCD, 135
LCD Contrast, 137
Letter mode, 45
Letter/Photo Mode Printing, 46
Loading Paper, 15
Longer Paper, 140

M

Machine Exterior, 1
Machine Interior, 2
Main Switch, 2
Maintaining Your Machine, 196
Make/Chg. Pattern, 146, 161
【**Make-Up**】key, 6
Make-up Printing, 105
Make-up Printing Features, 93
Make-up Printing With The Optional Document Feeder, 107
Make-up Samples, 110
Making Master And Prints At One Stroke, 49
Manual Class, 142
Manual Class Mode With 2 Or More Originals, 58
Manual Class Mode With 2 Or More Originals Using The Document Feeder, 84
Manual Class Mode With One Original, 56
Manual Quality Start, 76
Margin Erase Area, 139, 150
Master, 180
Master Cut Length, 143
Master Eject Indicator (⏏), 182
Master Eject Unit Front Handle E1, 3
Master End Indicator (⏏), 180
Master Feed Unit, 1
Master Misfeed In The Master Eject Section, 174, 175
Master Misfeed In The Master Feed Section, 173
Max. Quantity, 136
memory board, 91, 93, 113, 115, 117, 120, 122, 124
Memory Combine, 124
Merging Images, 113
Min. Quantity, 136
mm/inch, 135
Mode Setting, 139
Monitors, 8

MSTR Makg. Density, 137

N

Next, 9
No. of Q.start, 141, 152
No. of Skip Feed, 141, 151
No Orig. Size, 139
No Orig. Size (ADF), 139
Number keys, 7

O

OK, 9
Ppr. Size, 139
[On Line]key, 6
On Line Overlay, 113
On Line Printing, 80
Open Cover/Unit Indicator (☐*), 177
Operation Panel, 1, 6
Optional Document Feeder, 81
Options, 4
Original Misfeed, 175
Original Priority, 137
Originals, 13, 81
Overlay, 113
[Overlay] key, 6

P

Page Stamping, 117
Panel Beeper, 137
Panel Display, 8, 9
Paper Alignment Wing Knobs, 2
Paper Alignment Wings, 2
Paper Delivery End Plate, 2
Paper Delivery End Plate Knob, 2
Paper Delivery Side Plate Knobs, 3
Paper Delivery Side Plates, 3
Paper Delivery Tray, 2
Paper Feed Side/End Plate Knob, 1
Paper Feed Side/End Plates, 1
Paper Feed Tray, 1
Paper Feed Tray Down key, 1
Paper Misfeed In The Paper Exit Section, 172
Paper Misfeed In The Paper Feed Section, 168, 169
Paper Or Master Wrapped Around The Drum, 170
Paper Type, 137
PC controller, 80, 113
Pencil Mode Printing, 47

Photo (Lightness), 138
Photo Mode Printing, 45
Photo (Screen), 138
Platen Cover, 3
Poor Printing, 185
Position (Date), 145, 158
Position (Page), 146, 160
Position (User), 145, 156
Power connection, 194
Preset Reduce/Enlarge, 30
Prev., 9
Printing In Two Colors, 88
Printing Paper, 11
Printing Preset Messages On Your Prints, 120
Printing Secret Documents, 75
Printing Your Own Messages On Your Prints, 122
[Print] key, 7
Program, 72
[Program] key, 7
[Proof] key, 7
Protecting A Program, 73

Q

[Quality Start] key, 6
Quality Start Mode, 76

R

R. Counter Display, 135
Recalling A Program, 73
Reducing And Enlarging In 1 % Steps, 35
Reducing And Enlarging Using Preset Ratios, 30
Regaining The Image Density, 76
Reg/Chg KeyOpCode, 147
Regist. (User), 145, 158
Reg. User Code, 147
REMARKS, 189
Removing Program Protection, 74
Repeat, 129
Repeating An Image Over The Entire Print, 124
Replenishing Paper, 22
Reproduction Ratio, 138, 148
Reset Counters, 147, 163
Reset R. Counter, 135
Restricted Access, 147
Rotating Original Images, 91

S

Safety Information, i
Saving Ink, 48
Saving Master, 79
【Security】 key, 6
Security Mode, 75
Select, 9
Separating Printing Sets, 77
service call, 166
Set Operation Modes, 136
Setting Q.start, 141
Setting Up The Paper Delivery Tray, 16
Set User Code, 135, 146
Size, 144
Size (User Stamp), 144
【Skip Feed】 key, 6
Skip Feed Printing, 70
Skipped Prints, 188
Special Feature indicator, 8
Special Kinds Of Paper, 43
SPECIFICATIONS, 201
【Speed】 keys, 7
Stamp, 144
Stamp Density, 144
Stamping Date, 115
Stamping Function, 120
【Stamp】 key, 6
Stamp Position, 144, 154
Standard Printing, 20
【Start】 key, 7
Stopping The Machine During A
Multi-print Run, 29
Storing Your Settings, 72
Stretching And Squeezing The Image In
1 % Steps, 37
System, 135

T

Thick Paper, 42
Thin Paper, 42
Time Setting, 136, 148
【Tint】 key, 6
Tint Mode, 27
Tint Mode ON/OFF, 138
Trailing Edge Guides, 3
Type, 144
Type of Paper, 143, 154
Type (Page), 145

U

User Code, 146
User Codes, 19
User Stamping, 122
USER TOOLS, 133
【User Tools】 key, 6
User Tools Menu, 135

W

Warning, ii
What To Do If Something Goes Wrong,
165
What You Can Do With This Machine,
viii
Where To Put Your Machine, 193

Z

Zoom, 35